

Spectrum[®] Technologies, Inc.

"To Measure Is To Know"

2026 CATALOG
-Price Updates-

MARKETS SERVED

Agriculture

Row Crops
Small Grains

Horticulture

Fruit/Nut/Vegetable Farming
Greenhouse Growers

Research & Education

University Agriculture &
Horticulture Programs

Turf

Golf Courses
Sports Fields

PRODUCT SOLUTIONS

Weather Monitoring

Weather Stations
Sensors
Environmental Meters

Soil Measurement

TDR Soil Moisture Meters
Soil Compaction Meters
Soil Moisture Profiler
Soil EC Probes

Light Measurement

Quantum Meters
DLI Meters
UV Sensors

Plant Health

Chlorophyll Meters
pH/EC Meters
Nutrient Meters
Disease Monitoring

WatchDog Weather Stations



LightScout PAR/DLI Meters



Fieldscout Wireless pH Probes



Fieldscout Portable Soil Moisture Meters



Current Conditions
89951 Spectrum Technologies Data

Spectrum Weather Station
WD Wireless ET Station, WiFi
54500010
Data Time: 12/14/2023
12:10 PM

A1: Rainfall - 24-hour	☁️	★
0.00 inches		
B1: Temperature	🌡️	★
48.0 F		
B2: Relative Humidity	💧	☆
50.4 %		
C1: Wind Direction	🌀	☆
165 degrees (SSE)		
C2: Wind Gust	🌬️	★
mph		
Wind Speed		

**TECHNOLOGY IN THE
PALM OF YOUR HAND**

38 YEARS IN BUSINESS!

Spectrum[®] Technologies, Inc.



At Spectrum Technologies, we pride ourselves on helping our valued partners transform plant measurements into more profitable growing decisions. Since 1987, we have manufactured and distributed affordable, leading-edge plant measurement technology to agricultural, horticultural, greenhouse and turf markets globally, serving more than 14,000 customers in 80+ countries.

We proudly work alongside growers, researchers, golf course superintendents and industry suppliers to provide a broad line of measurement devices and software solutions to make viewing data simple and straightforward. Our technology allows for better environmental monitoring, soil moisture measurement, irrigation scheduling, as well as nutrient and pest management. We address common pain points throughout our markets: inconsistent crop yield, irregular blooms, micro-climates affecting playability on the golf course, as well as insect and disease infestation.

Our knowledgeable and friendly sales team works closely to understand and address your needs in order to identify the right product match. Ensuring our customers are satisfied with our products and services is top priority. We stand behind every product with our 100% Satisfaction Guarantee!

Thank you for your support and continued commitment to innovation. We look forward to partnering to grow your business!

Sincerely,

A handwritten signature in black ink that reads "Mike Thurow". The signature is written in a cursive, flowing style.

Mike Thurow
CEO & Founder



WEATHER MONITORING SOLUTIONS - Pages 4-23**WatchDog® Wireless Weather Stations - Pages 4-13**

Measure any combination of Wind Speed/Direction, Temperature, Relative Humidity, Rainfall and Solar Radiation based on your specific needs and choose your communication method.

- Cellular (LTE-CAT4 or LTE-M Modem)
- WiFi Modem
- 900 MHz Radio Communication
- Data Recorder (No Modem)

WatchDog A & B Series Data Loggers - Pages 14-15

Most economical method of tracking environmental conditions with continuous interval logging.

WatchDog Micro Weather Stations - Page 16

Cost effective options to record multiple environmental conditions using external sensors of your choice.

Weather Station Recertification Program - Page 17**Weather Station Sensors - Pages 18-21**

Choose from a variety of available sensors to measure what is important.

WatchDog Portable Wind Sensor - Page 22

Measure and record wind speed/direction with a portable, ultrasonic, bluetooth sensor that attaches to your phone, no mounting required.

WatchDog Sprayer Station - Page 23

Mount the station on your equipment for on the go monitoring and logging of wind speed/direction.

WatchDog Weather Station Comparison Chart - Pages 24-25

Compare all of your options!

SOIL MONITORING SOLUTIONS**FieldScout® TDR Series Soil Moisture Meters - Pages 26-28**

Measure soil moisture (VWC - volumetric water content %), salts (EC - electrical conductivity) and surface temperature with three handheld device options, perfect for spot measurements.

- TDR350
- TDR250
- TDR150

WaterScout® Soil Moisture Sensors - Pages 29-30

Permanently install or use with a WatchDog Weather Station to measure soil moisture (VWC), salts (EC), and temperature.

WaterScout Profiler - Page 31

Measure soil moisture (VWC) and temperature at up to 10 different depths in one probe!

Irrigation Stations - Page 32

Choose a pre-packaged solution to measure soil moisture (VWC) at different depths.

FieldScout Direct Soil EC Meter - Page 33

Instant and accurate direct electrical conductivity (EC) and temperature measurements.

FieldScout SC900 - Page 34

Measure soil compaction through penetration resistance.

FieldScout TruFirm - Page 35

Measure the firmness of turf, bunker sands and other playing surfaces.

LIGHT MONITORING SOLUTIONS - Pages 36-38**LightScout® Light Meters - Pages 36-38**

Measure the amount of light your plants are receiving.

- LightScout Full Spectrum Quantum PAR Light Sensor
- LightScout Full Spectrum Quantum PAR Light Meters
- LightScout Quantum PAR/DLI Light Meter
- LightScout External Light Sensor Reader
- LightScout Red/Far-Red Meter
- LightScout UV Meter
- LightScout Foot-Candle Meter

PLANT HEALTH SOLUTIONS - Pages 39-42**Chlorophyll Meters - Page 39-40**

Measure the chlorophyll content of your plants.

- SPAD Meters
- FieldScout CM1000 Chlorophyll Meter

NDVI Meters - Page 40

Measure red and near infrared spectral bands to estimate the green density in an area.

- FieldScout CM1000 NDVI Meter
- FieldScout TCM500 NDVI Turf Color Meter

FieldScout Wireless ISFET pH & pH/EC/ORP Probe - Page 41

Measure and track pH levels in soil and solutions.

LAQUA Nutrient Meters - Pages 42-43

"Lab in Hand" meters to measure pH, EC, Sodium, Potassium, Nitrate and Calcium.

DATA VIEWING OPTIONS**Mobile Apps - Pages 44-45**

Many of our product solutions provide the ability to connect to an app to view real time data from anywhere!

SpecWare - Pages 46-49

A downloadable software that allows you to view and analyze data collected from your compatible WatchDog products.

SpecConnect - Pages 50-53

A robust cloud based service that allows you view and analyze the data collected from your compatible WatchDog and FieldScout products on demand from your phone, PC or tablet. Data automatically syncs to SpecConnect and is viewable in real time.

OUR BRANDS MEASURE UP!



WatchDog®

WHAT MAKES YOU SUCCESSFUL?

Consistent, healthy crops, hearty flower blooms and dependable turf playing conditions make your business successful and easier to manage. Understanding current weather conditions in your field, greenhouse or on your golf course is vital to ensure these goals are met and addressed proactively.

Our **FULLY INTEGRATED** WatchDog Weather Stations provide the ability to record and communicate weather data so you have real time data access. Allow the information to guide your decisions regarding irrigation, frost, insect and disease control and nutrient management.

WHAT WEATHER STATION FITS MY NEEDS?

Step 1: Determine the measurements most important to you and choose the WatchDog model that has the integrated sensors you need.

3550/3250 Models: Temperature, Relative Humidity, Rainfall, Wind Speed/Direction, Solar Radiation

3540/3240 Models: Temperature, Relative Humidity, Rainfall, Wind Speed/Direction

3230 Models: Temperature, Relative Humidity, Quantum (PAR) Light

3220 Models: Temperature, Relative Humidity, Rainfall

3210 Models: Temperature, Relative Humidity

3580 Models: 8 Open Ports, choose the sensors you want

Step 2: Determine your preferred communication method based on where your weather station will be placed, signal strength and how you want to receive data.



Communication Options	Communication Description	How is Data Viewed?
C4 Cellular (LTE-CAT4 Modem)	Strongest cellular connection, best for less populated areas where an LTE-M connection can be a concern	Requires SpecConnect Cloud Service Subscription
MU Cellular (LTE-M Modem)	Best for well populated areas where there is a strong, consistent LTE-M connection	Requires SpecConnect Cloud Service Subscription
WF Wireless (WiFi Modem)	Wireless connection where connectivity is strong and consistent, when the weather station will be installed within service range of the WiFi network	Requires SpecConnect Cloud Service Subscription
DU 900Mhz Radio Communication (Mesh Network)	Radio communication uses a combination of WatchDog Pups/Retrievers in a mesh network. Ideal when data needs to be collected from micro climates within a larger field. A 1/2 mile line of sight view is required between devices. (see pages 8-11 for more information on the Pup/Retriever Network)	Requires SpecConnect Cloud Service Subscription OR SpecWare Software Purchase
DR Data Recorder (No Modem)	Ideal when real time data and constant monitoring is not required. Gather data in increments specified and then transfer data via USB flash drive or direct connect from the station to your PC. (see pages 12-13 for more information on Data Recorders)	Requires SpecWare Software Purchase

See pages 46-53 for details about SpecWare & SpecConnect

Step 3: Add any additional sensors for measurements you would like to monitor that are not already integrated into the weather station you choose.

- Soil Moisture Sensors
- Environmental Sensors
- Light Sensors
- Digital Sensors

See pages 18-21 for a comprehensive list of sensors available to add on to your weather station

Step 4: Place your order! Order directly on our website or contact your sales rep.

HOW DO I SET UP MY WEATHER STATION?

Your weather station will arrive with a quick start guide to get your station up and running instantly. Our WatchDog app will guide you through set up and allow you to immediately start tracking data as soon as your station is connected! Technology in the palm of your hand!

HOW DO I VIEW THE DATA?



Real time data is always viewable directly from the app if you choose a model with wireless data connection. Additionally, a subscription to SpecConnect, our cloud based service, is required with these models. This allows data to be sent to the cloud, where you can view current conditions or historical data using a broad selection of standard or customized analytical reports from anywhere in the world! Manipulate the data you collect to tell a story and guide your decisions on irrigation, fertilizing, labor needs, frost and pest control. **See pages 50-53 for details about SpecConnect.**

**SpecWare
Software**

For weather stations that do not include a modem, data can be downloaded to a USB Flash Drive and processed with SpecWare Software to view and analyze the previously collected data.

See pages 46-49 for details about SpecWare.

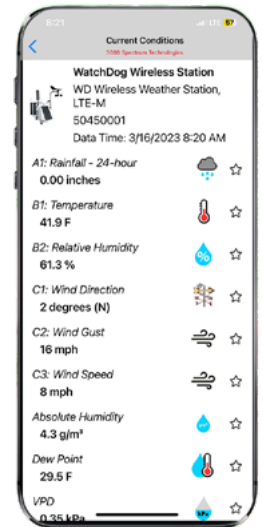

ANATOMY OF A WEATHER STATION



CELLULAR PADDLE

Used with cellular communication
(varies based on communication method)

RAIN BUCKET WITH BIRD GUARD

Measures rainfall,
keeps birds away

TEMP/RH SENSOR

Measures temperature
and humidity



ANEMOMETER

Measures wind
speed and direction

SOLAR RADIATION

Measures the intensity of the
sun's radiation, used to calculate
evapotranspiration (ET)

SOLAR PANEL

Uses sunlight to supply
power to the station

The durable enclosure provides
moisture, corrosion and UV protection for
increased reliability in harsh environments





WIRELESS ET WEATHER STATION OPTIONS (Models 3550 & 3250)

Measures: Temperature, Relative Humidity, Rainfall, Wind Speed/Direction and Solar Radiation (ET)

Additional Sensor Ports Available: 5 for 3550 Models and 1 for 3250 Models

MOST POPULAR! Evapotranspiration (ET) is calculated from the data collected, provides the greatest amount of data to guide your decision making.

3550 Models - 5 Available Sensor Ports		
Item #	Communication Options	Price
3550C4	Cellular (LTE-CAT4 Modem)	\$2,995
3550MU	Cellular (LTE-M Modem)	\$2,830
3550WF	WiFi Modem	\$2,995
3550DU	900Mhz Radio Communication	\$2,725
3550DR	Data Recorder (No Modem)	\$2,510

3250 Models - 1 Available Sensor Port		
Item #	Communication Options	Price
3250C4	Cellular (LTE-CAT4 Modem)	\$2,675
3250MU	Cellular (LTE-M Modem)	\$2,515
3250WF	WiFi Modem	\$2,395
3250DU	900Mhz Radio Communication	\$2,400
3250DR	Data Recorder (No Modem)	\$2,200

WIRELESS STANDARD WEATHER STATION OPTIONS (Models 3540 & 3240)

Measures: Temperature, Relative Humidity, Rainfall, Wind Speed/Direction

Additional Sensor Ports Available: 6 for 3540 Models and 2 for 3240 Models

3540 Models - 6 Available Sensor Ports		
Item #	Communication Options	Price
3540C4	Cellular (LTE-CAT4 Modem)	\$2,675
3540MU	Cellular (LTE-M Modem)	\$2,515
3540WF	WiFi Modem	\$2,395
3540DU	900Mhz Radio Communication	\$2,400
3540DR	Data Recorder (No Modem)	\$2,200

3240 Models - 2 Available Sensor Ports		
Item #	Communication Options	Price
3240C4	Cellular (LTE-CAT4 Modem)	\$2,345
3240MU	Cellular (LTE-M Modem)	\$2,200
3240WF	WiFi Modem	\$2,075
3240DU	900Mhz Radio Communication	\$2,075
3240DR	Data Recorder (No Modem)	\$1,855

WIRELESS PLANT GROWTH STATION (Model 3230)

Measures: Temperature, Relative Humidity, Quantum (PAR) Light

Additional Sensor Ports Available: 1

- Includes an aluminum stand for bench use.

Choose from three models that match your supplemental lighting.

STANDARD: Includes the 3668S PAR light sensor to measure broadband light sources such as Sunlight, HPS, HID and Fluorescent

PRO: Includes the 3668A Full Spectrum PAR light sensor to measure all light sources, including LED

ASPIRATED: Includes an aspirated radiation shield for the Temp/RH sensor and the 3668A Full Spectrum PAR light sensor to measure all light sources, including LED

3230 Models - 1 Available Sensor Port			
	Item #	Communication Options	Price
STANDARD	3230C4	Cellular (LTE-CAT4 Modem)	\$2,570
	3230MU	Cellular (LTE-M Modem)	\$2,395
	3230WF	WiFi Modem	\$2,395
	3230DU	900Mhz Radio Communication	\$2,075
	3230DR	Data Recorder	\$1,855
PRO	3230C4P	Cellular (LTE-CAT4 Modem)	\$2,780
	3230MUP	Cellular (LTE-M Modem)	\$2,510
	3230WFP	WiFi Modem	\$2,510
	3230DUP	900Mhz Radio Communication	\$2,510
ASPIRATED	3230DRP	Data Recorder	\$2,295
	3230C4A	Cellular (LTE-CAT4 Modem)	\$2,995
	3230MUA	Cellular (LTE-M Modem)	\$2,940
	3230WFA	WiFi Modem	\$2,830
	3230DUA	900Mhz Radio Communication	\$2,730
	3230DRA	Data Recorder	\$2,615

WIRELESS RAIN STATION OPTIONS (Model 3220)

Measures: Temperature, Relative Humidity, Rainfall

Additional Sensor Ports Available: 2

Monitor rainfall, temperature and humidity in remote fields to effectively manage irrigation scheduling and adjust field activities to avoid soil compaction.

3220 Models - 2 Available Sensor Ports		
Item #	Communication Options	Price
3220C4	Cellular (LTE-CAT4 Modem)	\$1,855
3220MU	Cellular (LTE-M Modem)	\$1,695
3220WF	WiFi Modem	\$1,570
3220DU	900Mhz Radio Communication	\$1,530
3220DR	Data Recorder (No Modem)	\$1,360



900Mhz Radio

WIRELESS TEMP/RH STATION OPTIONS (Model 3210)

Measures: Temperature, Relative Humidity

Additional Sensor Ports Available: 2

Prevent frost damage with temperature alerts sent directly to your phone (requires separate SpecConnect Alert Package Subscription). Monitor site-specific conditions for insect and disease pressure with an optional leaf wetness sensor.

3210 Models - 2 Available Sensor Ports		
Item #	Communication Options	Price
3210C4	Cellular (LTE-CAT4 Modem)	\$1,570
3210MU	Cellular (LTE-M Modem)	\$1,420
3210WF	WiFi Modem	\$1,310
3210DU	900Mhz Radio Communication	\$1,310
3210DR	Data Recorder (No Modem)	\$1,090



**Data Recorder
(No Modem)**

WIRELESS SENSOR STATION OPTIONS (Model 3580)

Measures: YOU CHOOSE WHAT YOU WANT TO MEASURE!

Additional Sensor Ports Available: 8

Our most versatile model! Choose every sensor and measure what you need. Monitor the plant inputs that are important to you! Perfect when multiple sensors of the same type are needed at different depths.

3580 Models - 8 Available Sensor Ports		
Item #	Communication Options	Price
3580C4	Cellular (LTE-CAT4 Modem)	\$1,745
3580MU	Cellular (LTE-M Modem)	\$1,570
3580WF	WiFi Modem	\$1,420
3580DU	900Mhz Radio Communication	\$1,420
3580DR	Data Recorder (No Modem)	\$1,310



**Sensor Station
(Additional Ports)**



HOW DOES RADIO COMMUNICATION WORK?

Our Retriever and Pups Solution is the right answer if you want to collect multiple data points in one field, vineyard or golf course. Monitor the factors important to keeping your crops and greens healthy and fruitful! When you set up the network, included devices talk to each other as long as each is within a 1/2 mile line of sight of another device. Information is transmitted to the Retriever. You can download the data via USB or view it live in the WatchDog App and through SpecConnect if you incorporate a modem into your network. Sound complicated?

LET'S BREAK IT DOWN!

WHAT IS A PUP STATION?

A Pup Station is a weather station that uses radio communication. They are distinguished by DU in the part number. The pre-determined measurements described on the previous two pages allow you to pick what station is the right choice based on what you want to measure.

WHAT IS A SENSOR PUP?

A Sensor Pup allows you to connect up to four external sensor inputs each. Choose the sensors you want based on the measurements you are trying to obtain. The Sensor Pup transmits data to the Retriever directly or via other Pups.

- Includes 6 lithium AA batteries, solar power optional
- Single Button Operation - check battery status, signal strength and join sensor network
- Tri-colored LED indicates battery level, signal strength and data communication status

WHAT IS A REPEATER PUP?

A Repeater Pup serves as a "signal extender" to provide a path for signal transmission around obstacles or to extend range. It looks the same as a Sensor Pup but has no sensor inputs. It merely helps transmit data from the other devices in the network to the Retriever.

- Includes 6 lithium AA batteries, solar power optional

WHAT IS A SENSOR?

A sensor is a device that plugs into a Pup Station or Sensor Pup to measure data such as Rainfall, Temp/RH, Soil Moisture, Leaf Wetness, Light, Wind, etc.

WHAT IS A RETRIEVER?

A Retriever is the vehicle used to collect all the data from the network of Pup Stations and/or Sensor Pups. Every Retriever can support up to 12 pups. All devices in the network must be placed within a 1/2 mile line of sight (approximately 2,500 feet) of each other to keep data flowing through the network to the Retriever.

- 900MHz radio
- Includes USB flash drive and USB data cable to easily download data and view on your computer
- Includes 6 lithium AA batteries, solar power optional.
- Single Button Operation - switch modes, download data, upload configuration and check battery status
- Tri-colored LED indicates mode, battery level, data communication status and configuration status



WHAT ABOUT A MODEM?

A DataScout modem communicates the data to the web using either a cellular or wifi signal.

You DO NOT Need a Modem IF...you only want to download data from the Retriever onto the included USB drive and then view on your computer using our SpecWare Software

You DO Need a Modem IF...you want to send data to the SpecConnect Cloud to view and manipulate into relevant reports.

- Single Button Operation - test communications, pair with station and check battery level
- Tri-Colored LED indicates battery level, data communications and wireless signal/connection status
- Power Options - choose between solar power or AC/DC power

HOW DO I VIEW THE DATA?

Real time data is always viewable directly from the WatchDog app on your phone.

SpecWare
Software

If you prefer to not use a modem and decide to download the data to a USB drive, you can purchase our SpecWare Software to view and analyze the previously collected data.

See pages 46-49 for details about SpecWare.



SpecConnect

If you use a modem, a subscription to our cloud based service called SpecConnect is required. This allows data to be sent to the cloud, where you can view current conditions or historical data using a broad selection of standard or customized analytical reports from anywhere in the world!

Manipulate the data you collect to tell a story and guide your decisions on irrigation, fertilizing, labor needs, frost and pest control.
See pages 50-53 for details about SpecConnect.





Item #	Item Description	Price
STEP 1 - CHOOSE YOUR PUP(S)		
3550DU	Wireless ET Pup Station - 5 Available External Sensor Ports <i>(Wind Speed/Direction, Temperature, Relative Humidity, Rainfall, Solar Radiation)</i>	\$2,745.00
3250DU	Wireless ET Pup Station - 1 Available External Sensor Port <i>(Wind Speed/Direction, Temperature, Relative Humidity, Rainfall, Solar Radiation)</i>	\$2,400.00
3540DU	Wireless Standard Pup Station - 6 Available External Sensor Ports <i>(Wind Speed/Direction, Temperature, Relative Humidity, Rainfall)</i>	\$2,400.00
3240DU	Wireless Standard Pup Station - 2 Available External Sensor Ports <i>(Wind Speed/Direction, Temperature, Relative Humidity, Rainfall)</i>	\$2,075.00
3230DU	Wireless Plant Growth Pup Station - 1 Available External Sensor Port <i>(Temperature, Relative Humidity, PAR Light)</i>	\$1,855.00
3220DU	Wireless Rain Pup Station - 2 Available External Sensor Ports <i>(Temperature, Relative Humidity, Rainfall)</i>	\$1,530.00
3210DU	Wireless Temp/RH Pup Station - 2 Available External Sensor Ports <i>(Temperature, Relative Humidity)</i>	\$1,310.00
3580DU	Wireless Sensor Pup - 8 Available External Sensor Ports <i>(Choose Your Sensors)</i>	\$1,420.00
3900	Sensor Pup - 4 Available External Sensor Ports	\$ 605.00
3902	Repeater Pup - No Sensor Ports	\$ 605.00
STEP 2 - CHOOSE YOUR SENSORS		
3613ARS	Temperature/RH Sensor with Aspirated Radiation Shield	\$604.00
3613THS	Temperature/RH Sensor with Passive Radiation Shield	\$218.00
3665RD	Digital Rain Collector with Bird Guard <i>(For Sensor Pup Only)</i>	\$327.00
3305ADD	Digital Anemometer <i>(For Sensor Pup Only)</i>	\$428.00
6470-20	WaterScout SMEC300 Sensor with 20' (6.1m) Cable	\$275.00
6460-20	WaterScout SM100 Sensor with 20' (6.1m) Cable	\$125.00
6450WD20	Watermark Sensor with 25' (7.6m) Cable	\$125.00
3667	External Soil Temperature Sensor with 6' (1.8m) Cable	\$ 98.00
3666	Leaf Wetness Sensor	\$175.00
3670I	LightScout Silicon Pyranometer	\$320.00
3668S	LightScout Quantum Light Sensor	\$317.00
STEP 3 - ADD YOUR RETRIEVER (REQUIRED)		
3910	WatchDog Retriever	\$710.00
STEP 4 - CHOOSE YOUR MODEM (NOT REQUIRED)		
3933M	LTE CAT-4 Modem	\$1,090.00
3928M	LTE-M Modem	\$985.00
3920	WiFi Modem - AC/DC Powered	\$730.00

Item #	Item Description	Price
STEP 5 - ADD OPTIONAL ITEMS		
3999	Solar Power Package for Pups & Retrievers <i>(Includes 5W solar panel and 6V 4.5Ah rechargeable battery)</i>	\$325.00
3396TPS	Tripod Mount with Stakes	\$144.00
3925	Antenna Extension Cable - 10' (3m) <i>(Includes mounting bracket and hardware for use with Pups/Retrievers)</i>	\$ 88.00
3927C75	PC Direct Connection Cable - 75' (23m) <i>(Connect your Retriever directly to your PC. Includes power and data cables, AC/DC power adapter and DC plug adapter. Has 9-pin serial connection on PC end, may require USB adapter (Item #366IU9 - see page 21)</i>	\$139.00
3926	AC/DC Power Adapter for WatchDog Retriever 12V/0.7a	\$ 28.00

Wireless ET Pup Station (Item #3250DU)

Monitor evapotranspiration (ET) to effectively manage irrigation with respect to soil moisture loss. Includes sensor for Rain, Temp/RH, Solar Radiation and Wind Speed and Direction.



Wireless Standard Pup Station + SMEC300 Soil Moisture/EC/Temp Sensor (Item #3240DU + Item #6470-20)

Monitor weather above and soil moisture below ground to effectively manage irrigation, plan spray applications and schedule field activity.



Wireless Rain Pup Station + Leaf Wetness Sensor (Item #3220DU + Item #3666)

Monitor rainfall for more effective irrigation scheduling and to adjust field activities to avoid soil compaction. Monitor and note site-specific conditions for disease and insect pressure.

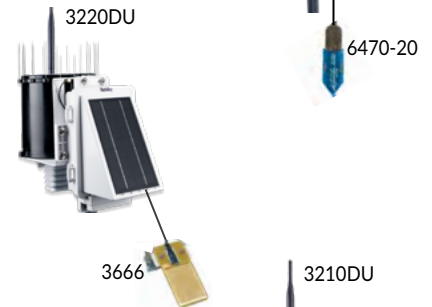

Wireless Temp/RH Pup Station + SMEC300 Soil Moisture/EC/Temp Sensor + SM100 Soil Moisture Sensor (Item #3210DU + Item #6470-20 + Item #6460-20)

Detect frost and be alerted to conditions in your crops. Monitor and note site-specific conditions for insect pressure. Remotely monitor soil moisture at two depths.



Wireless Sensor Pup + SMEC300 Soil Moisture/EC/Temp Sensor + SM100 Soil Moisture Sensor (Item #3900+ Item #6470-20 + Item #6460-20)

Flexibly monitor both soil moisture and/or EC in a variety of soil textures for better irrigation decisions.

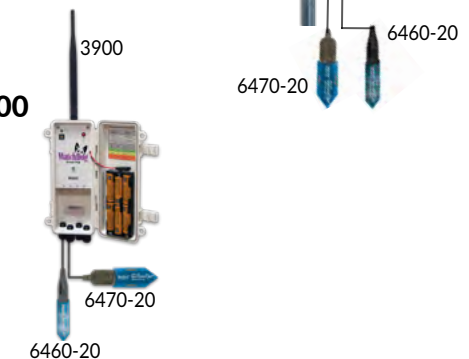

WHAT IS A DATA RECORDER?

Spectrum's WatchDog Station Data Recorders are ideal when real time data and around the clock monitoring are not needed. This economical option is



perfect to gather measurements and data that is important to you, but on your own schedule. Data can be transferred from the internal recorder to a USB flash drive and processed with SpecWare Pro Software. The 3000 Series Data Recorders offer all-in-one simple setup. With Bluetooth connectivity and the free WatchDog mobile app, they are perfect for fields, orchards, vineyards and greenhouses.

HOW DO I VIEW THE DATA?

SpecWare: SpecWare Software is required to view and analyze the collected data

Direct Connect: Download from the station to your PC via 75' (22.9m) cable or short range modem pair

USB Flash Drive: Transport data from your station to your PC (*USB drive not provided*)

PLANT GROWTH STATIONS

In addition to our 3230 Model plant growth stations (*see page 6*), we also have an option that is ideal for greenhouses. Our 2475 Mini Station (below and page 13) is more compact and computes and displays daily light integral (DLI), dew point and degree days. There is a live display of current light and cumulative light over the day. It computes and displays average day/night temperature differences (DIF) and vapor pressure deficit (VPD).

Plant Growth Station Data Recorder (Item #3230DR)



2475 Plant Growth
Mini Station Data Recorder
(Item #3686WDS)



Item #	Item Description	Price
WatchDog Station Data Recorders		
3550DR	ET Station Data Recorder - 5 Available External Sensor Ports <i>(Wind Speed/Direction, Temperature, Relative Humidity, Rainfall, Solar Radiation)</i>	\$2,510
3250DR	ET Station Data Recorder - 1 Available External Sensor Port <i>(Wind Speed/Direction, Temperature, Relative Humidity, Rainfall, Solar Radiation)</i>	\$2,200
3540DR	Standard Station Data Recorder - 6 Available External Sensor Ports <i>(Wind Speed/Direction, Temperature, Relative Humidity, Rainfall)</i>	\$2,200
3240DR	Standard Station Data Recorder - 2 Available External Sensor Ports <i>(Wind Speed/Direction, Temperature, Relative Humidity, Rainfall)</i>	\$1,855
3230DR	Plant Growth Station Data Recorder - 1 Available External Sensor Port <i>(Temperature, Relative Humidity, PAR Light)</i>	\$2,075
3230DRP	Plant Growth Station Data Recorder Pro - 1 Available External Sensor Port <i>(Temperature, Relative Humidity, PAR Light)</i>	\$2,295
3230DRA	Plant Growth Station Data Recorder Aspirated - 1 Available External Sensor Port <i>(Temperature, Relative Humidity, PAR Light)</i>	\$2,615
3220DR	Rain Station Data Recorder - 2 Available External Sensor Ports <i>(Temperature, Relative Humidity, Rainfall)</i>	\$1,360
3210DR	Temp/RH Station Data Recorder - 2 Available External Sensor Ports <i>(Temperature, Relative Humidity)</i>	\$1,090
3580DR	Sensor Station Data Recorder - 8 Available External Sensor Ports <i>(Choose Your Sensors)</i>	\$1,310
3686WDS	2475 Plant Growth Mini Station Data Recorder - 1 Available External Sensor Port <i>(Temperature, Relative Humidity, PAR Light, Dew Point)</i>	\$1,205

WHAT IS A DATA LOGGER?

Spectrum's WatchDog Data Loggers are ideal when real time data and constant round the clock monitoring is not needed. This economical option is perfect to gather data that is important to you, but on your own schedule. Data Loggers are perfect for areas where multiple measurements may be needed on one plot of land, but having multiple stations is not feasible or is cost prohibitive. Requires purchase of SpecWare Software to view and analyze the data.

A-SERIES DATA LOGGERS

The most affordable way to track environmental conditions for analysis!

- Log 4,000-8,000 intervals
- Removable soft caps keep ports clear of debris
- Water resistant (IP65/IP54) case (*Model A160/3611A is for indoor use only*)
- 12 month battery life (CR2 battery included)



HOW DO I VIEW THE DATA?

- The LCD display on the logger confirms operation and displays last sensor reading
- Download the data by connecting the logger directly to your computer with the PC connection cable
- Requires purchase of SpecWare Software to view and analyze the data

B-SERIES DATA LOGGERS

Pocket sized, efficient and inexpensive logging technology

- Log 2,000-8,000 intervals
- Water resistant (IP56) stainless steel case
- Integral non-replaceable battery



HOW DO I VIEW THE DATA?

- Snap the B-Series Data Logger into the Docking Station and connect it to your PC to see the data
- Requires purchase of SpecWare Software to view and analyze the data

DATA LOGGING RAIN GAUGE

High accuracy, low maintenance tipping bucket rain collector

- Meets NWS guidelines with an 8" (20.5cm) diameter collector
- The included data logger can log up to 10,584 intervals
- Select intervals from 1 to 60 minutes (maximum 10.23" (26cm) per interval)
- Record rainfall in either metric (mm) or US (in) units
- Rain collector mounting bracket and hardware included
- Includes Bird Guard to reduce maintenance
- Accuracy: $\pm 2\%$ at $< 2"$ (5cm) per hour



HOW DO I VIEW THE DATA?

SpecWare: Requires purchase of SpecWare Software to view and analyze the data

Direct Connect: Download from the station to your PC

Data Shuttle: Download data from the unit and then direct connect to your PC



Model #	Item #	Internal Sensor	Intervals	Radiation Shield	Price
A-SERIES DATA LOGGERS					
A160	3611A	Air Temperature, Relative Humidity, CO ₂	5,333	Indoor Use Only (No Shield Available)	\$245.00
A150	3612A	Air Temperature, Relative Humidity	5,333	Optional	\$135.00
A130	3610A	Air Temperature, External Leaf Wetness	4,000	Optional	\$295.00
A125	3617A	Air Temperature, External Temperature	4,000	Optional	\$149.00
A110	3618A	Air Temperature	8,000	Optional	\$ 74.00
-----	3661A	WatchDog A-Series PC Connection Cable USB Port <i>(required to download data)</i>			\$ 37.00
-----	3663	Radiation Shield <i>(needed for outdoor use)</i>			\$ 79.00
Model #	Item #	Internal Sensor	Intervals	LCD Display	Price
B-SERIES DATA LOGGERS					
B102	3621WD	Temperature, Relative Humidity	4,000	No	\$495.00
	Temperature Range: -40°F to 85°F (-20°C to 85°C) Humidity: 0 to 100%, ±5% Temperature Accuracy: ±1.1°F from 5°F to 149°F (±0.6°C from -15°C to 65°C)				
B101 8K	3620WD	Temperature	8,000	No	\$295.00
	Temperature Range: -40°F to 85°F (-20°C to 85°C) Temperature Accuracy: ±1.1°F from 5°F to 149°F (±0.6°C from -15°C to 65°C)				
B100 2K	3619WD	Temperature	2,000	No	\$129.00
	Temperature Range: -40°F to 85°F (-20°C to 85°C) Temperature Accuracy: ±1.8°F from -22°F to 158°F (±1°C from -30°C to 70°C)				
-----	3655K1	WatchDog B-Series Docking Station USB Port <i>(required to download data)</i>			\$180.00
Item #	Item Name				Price
RAIN GAUGE DATA LOGGER					
3554WD1	WatchDog 1120 Data Logging Rain Gauge				\$495.00

What is a Micro Station?

WHAT IS A MICRO STATION?

Micro Stations offer a cost-effective way to record multiple environmental conditions over a period of time. Internal sensors can include temperature and humidity. Whether you need plant disease or soil moisture monitoring, the WatchDog 1000 Series Micro Station will deliver the information you need for timely, accurate data to make more informed decisions to help increase profits. The LCD display confirms station operation and provides current sensor readings. View the current temperature during a frost event, or soil moisture prior to irrigating – without downloading to a PC. Customizable with up to four unique external plug-in sensors. Change monitoring parameters from one season to the next, simply by connecting a different sensor - keeping investment costs down while making more profitable decisions.



Up to 4 external sensor ports and ability to measure up to 8 sensor values depending on the model chosen

- LCD screen displays sensor readings and battery level
- Choose measurement intervals from 1 to 60 minutes
- Log up to 10,584 intervals
- 12 month battery life (CR2450 battery included)



HOW DO I VIEW THE DATA?

Data is stored in the Micro Station until you download it from the station to your PC.

SpecWare: Requires purchase of SpecWare Software to view and analyze the data

Direct Connect: Download from the station to your PC

Data Shuttle: Download data from the unit and then direct connect to your PC

Model/Item Number	Internal Sensor	External Ports	Maximum # SMEC300 Sensors	Price
1650/3688WD1	Temperature, Relative Humidity	4	2	\$520.00
1525/3687WD1	Temperature	4	2	\$430.00
1450/3684WD1	Temperature, Relative Humidity	2	1	\$430.00
1425/3683WD1	Temperature	3	1	\$375.00
1400/3685WD1	None (External Only)	4	2	\$360.00
1250/3682WD1	Temperature, Relative Humidity	None	0	\$355.00
1225/3681WD1	Temperature	1	0	\$300.00
1200/3680WD1	None (External Only)	2	1	\$280.00
1120/3554WD1	Rainfall	None	0	\$495.00
1115/3635WD1	Requires External Rainfall (see website)	1	0	\$275.00



3000 Series, 2000 Series and 1000 Micro Series Weather Station Recertification Program

Our products are designed to provide the highest level of accuracy, reliability and ruggedness you deserve. We make every effort to produce the most durable and long lasting products available today. Over time, certain components are subject to wear and tear. Lightning, rain, snow, salt spray and extreme temperatures all take their toll. Because of this and because we know how important accurate data is to you, we offer a Recertification Program for our weather stations. This program enables you to send your hardware to our Aurora, IL facility, where it undergoes a complete diagnostic check-up.

Diagnostic Check-Up

Each check-up includes an inspection of the complete module and wiring, updates to the latest firmware and accuracy checks on all stations. You will receive a Weather Station Functionality Report detailing our testing. If any components of the weather station are found not to be within the published specifications, you will be notified for recommended replacements*. After authorization for replacement is received, each component will be calibrated and tested.

One Year Warranty and Turnaround Time

After the station has been recertified, a one year warranty will apply to all parts replaced during the recertification process. The turnaround time for recertification of a weather station is estimated at 14 days from the time it is received.

Item #	Item Description	Price
3300C	Weather Station Recertification - 2000 Series Stations	\$307.00
3500C	Weather Station Recertification - 3000 Series Stations	\$307.00
3600C	Weather Station Recertification - 2000 Series Mini Stations	\$198.00
3680C	Weather Station Recertification - 1000 Series Micro Stations	\$ 99.00









*The fee for recertification does not include the cost for any recommended replacement parts/sensors or return shipping

	3250 ET Weather Station	3240 Weather Station	3220 Rain Station	Range	Accuracy
Air Temperature	Included	Included	Included	-40°F to 257°F (-40°C to 125°C)	± 0.54°F (-40°F to 194°F)
Relative Humidity	Included	Included	Included	0 to 100%	± 2% @ 77°F (25°C)
Rainfall	Included	Included	Included	0.01" (0.254mm) resolution	± 2% at <2" (5cm)/hour
Wind Speed	Included	Included	Optional	0, 1 to 200mph (0, 1 to 322km/h)	± 2mph (± 3km/h) ± 5%
Wind Direction	Included	Included	Optional	1°-359°, 1° increments	±3°







The NEW WaterScout Profiler is only compatible with the 3500 Weather Station Models

SOIL SENSORS			
Item Description	Item #	Item Description	Price
WATERSCOUT SMEC300 Measures: VWC/EC/Temperature VWC: 0 to Saturation (typically 50%) Accuracy: ±3% EC: 0 to 10mS/cm Accuracy: ±2% COMPATIBILITY: WatchDog Pups, 3000, 2000 and 1000 Stations <i>*Requires purchase of WaterScout calibration device for accurate EC</i>	6470-6	WaterScout SMEC300 with 6' (1.8m) Cable	\$265.00
	6470-20	WaterScout SMEC300 with 20' (6.1m) Cable	\$275.00
	6470CAL3V	WaterScout EC Calibration Device	\$ 94.50
	2251	Conductivity Standard 1.41mS/cm, 250mL	\$ 31.00
 WATERSCOUT SM100 Measures: VWC VWC: 0 to Saturation Accuracy: ±3% COMPATIBILITY: WatchDog Pups, 3000, 2000 and 1000 Stations	6460	WaterScout SM100 Sensor with 6' (1.8m) Cable	\$ 115.00
	6460-20	WaterScout SM100 Sensor with 20' (6.1m) Cable	\$125.00
WATERMARK SOIL MOISTURE SENSOR Measures: Water tension Tension: 0 to 200 Centibars COMPATIBILITY: WatchDog Pups, 3000, 2000 and 1000 Stations	6450WD	Watermark Sensor with 11' (3.3m) Cable	\$ 99.75
	6450WD20	Watermark Sensor with 25' (7.6m) Cable	\$125.00
 EXTERNAL SOIL TEMPERATURE SENSOR Measures: Soil, Air or Water Temperature Range: -25°F to 212°F (-32°C to 100°C) Accuracy: ±1°F (0.5°C) COMPATIBILITY: WatchDog Pups, 3000, 2000 and 1000 Stations	3667	External Soil Temperature Sensor with 6' (1.8m) Cable	\$ 98.00
	3667-20	External Soil Temperature Sensor with 20' (6.1m) Cable	\$ 109.00
ENVIRONMENTAL SENSORS			
Item Description	Item #		Price
TEMPERATURE (MICRO) SENSOR Measures: Surface Temperature of leaves, buds or other tiny mediums Range: -25°F to 212°F (-32°C to 100°C) Accuracy: ±1°F (0.5°C) COMPATIBILITY: WatchDog Pups, 3000, 2000 and 1000 Stations	3667S		\$ 125.00
LEAF WETNESS SENSOR Measures: Leaf wetness with a resistance based sensor designed to replicate a leaf Range: 0 (Dry) to 15 (Wet) COMPATIBILITY: WatchDog Pups, 3000, 2000 and 1000 Stations	3666		\$175.00
TIPPING BUCKET RAIN COLLECTOR Measures: Rainfall in 1/100" increments, self emptying and freeze resistant Range: 0.01" (0.25mm) Accuracy: <2" (5cm) per hour COMPATIBILITY: WatchDog 3x10, 3x30, 2000 Mini and 1000 Stations	3665R		\$320.00

LIGHT SENSORS			
Item Description	Item #		Price
FULL SPECTRUM QUANTUM PAR LIGHT SENSOR Measures: PAR light between 400-700nm across the full PAR spectrum Range: 0 to 3000 $\mu\text{mol}/\text{m}^2\text{s}^{-1}$ Accuracy: $\pm 5\%$ COMPATIBILITY: WatchDog Pups, 3000 and 2000 Stations	3668A		\$445.00
LIGHTSCOUT QUANTUM LIGHT SENSORS Measures: PAR light between 400-700nm from broadband sources Sensor bars average PAR light readings to minimize effects of small shadows Sensor bars are 19" (48cm) long and include mounting brackets Range (Micro Stations): 0 to 2,500 $\mu\text{mol}/\text{m}^2\text{s}^{-1}$ Accuracy: $\pm 5\%$ Range (Other Stations/Pups): 0 to 3,000 $\mu\text{mol}/\text{m}^2\text{s}^{-1}$ Accuracy: $\pm 5\%$ COMPATIBILITY: WatchDog Pups, 3000, 2000 and 1000 Stations	3668S (1 sensor) 3668S6 (6 sensors)		\$317.00 \$415.00
LIGHTSCOUT SILICON PYRANOMETER Measures: Solar Radiation between 300-1,100nm Range (Micro Stations): 0 to 1,250W/m ² Accuracy: $\pm 5\%$ Range (Other Stations/Pups): 0 to 1,500W/m ² Accuracy: $\pm 5\%$ COMPATIBILITY: WatchDog Pups, 3000, 2000 and 1000 Stations	3670I		\$320.00
LIGHTSCOUT UV LIGHT SENSOR Measures: UV Radiation between 250-400nm Range: 0 to 200 $\mu\text{mol}/\text{m}^2\text{s}^{-1}$ Accuracy: $\pm 5\%$ COMPATIBILITY: WatchDog Pups, 3000, 2000 and 1000 Stations	3676I		\$349.00
DIGITAL SENSORS			
Item Description	Item #		Price
DIGITAL TEMPERATURE/RH SENSOR WITH ASPIRATED RADIATION SHIELD Measures: Temperature and Relative Humidity (includes 6' (2m) cable) and solar charging system to power internal fan) Range: -40°F to 212°F (-40°C to 100°C), 0 to 100% RH Accuracy: $\pm 0.54^\circ\text{F}$ from 50°F to 131°F ($\pm 0.3^\circ\text{C}$ from 10°C to 55°C), $\pm 2.5\%$ RH Operating Temperature: 14°F to 140°F (-10°C to 60°C) COMPATIBILITY: WatchDog Pups, 3500 Stations and 3200 Stations shipped after 2/1/24	3613ARS		\$604.00
DIGITAL TEMPERATURE/RH SENSOR WITH PASSIVE RADIATION SHIELD Measures: Temperature and Relative Humidity (includes 6' (2m) cable) Range: -40°F to 212°F (-40°C to 100°C), 0 to 100% RH Accuracy: $\pm 0.54^\circ\text{F}$ from 50°F to 131°F ($\pm 0.3^\circ\text{C}$ from 10°C to 55°C), $\pm 2.5\%$ RH Operating Temperature: 14°F to 140°F (-10°C to 60°C) COMPATIBILITY: WatchDog Pups, 3500 Stations and 3200 Stations shipped after 2/1/24	3613THS		\$218.00
DIGITAL RAIN COLLECTOR Measures: Rainfall in 1/100" increments, self emptying and freeze resistant Range: 0.01" (0.25mm) Accuracy: <2" (5cm) per hour COMPATIBILITY: WatchDog Sensor Pup (Item #3900) ONLY	3665RD		\$327.00
DIGITAL ANEMOMETER Measures: Wind Speed/Direction [includes 40' (12.2m)] Range (Wind Direction): 0 to 359° Accuracy: $\pm 3^\circ$ Range (Wind Speed): 0,1 to 200mph (321 km/hr) Accuracy: $\pm 2\text{mph}$ ($\pm 3\text{km/h}$), $\pm 5\%$ COMPATIBILITY: WatchDog Sensor Pup (Item #3900) ONLY	3305ADD		\$428.00
DIGITAL BAROMETRIC PRESSURE SENSOR Measures: Atmospheric Pressure Range: 8.86inHg to 36.9inHg (300hPa to 1250hPa) Accuracy: $\pm 0.03\text{inHg}$ ($\pm 1\text{hPa}$) COMPATIBILITY: WatchDog 3500 Stations and 3200 Stations shipped after 2/1/24	3671D		\$157.00

MISCELLANEOUS SENSOR CABLES			
Item Description	Item #		Price
GENERAL INPUT CABLES Connect Non-WatchDog Sensors to your WatchDog Station Range (3673): 0 to 3V Accuracy: ±0.005V Range (3674): 0 to 20.1mA Accuracy: ±1% COMPATIBILITY: WatchDog Pups, 3000, 2000 and 1000 Stations	3673 0-3V Input Cable		\$ 22.00
	3674 4-20mA Input Cable		\$ 33.00
SENSOR EXTENSION CABLE 20' (6m) Extension for all sensors (except digital) Connect up to 3 cables per sensor to extend reach COMPATIBILITY: WatchDog Pups, 3000, 2000 and 1000 Stations	3664		\$ 29.50
MISCELLANEOUS ACCESSORIES			
Item Description	Item #		Price
TRIPOD MOUNT Rugged galvanized steel folding tripod and 3' (1m) pole COMPATIBILITY: WatchDog Pups, 3000 and 2000 Stations	3396TPS <i>(with ground stakes)</i>		\$144.00
	3396TP <i>(without ground stakes)</i>		\$129.00
BIRD GUARD Reduce debris and maintenance and improve accuracy Adjustable to fit 8" (20.3cm) diameter rain collectors COMPATIBILITY: WatchDog Pups, 3000 and 2000 Stations, Rain Collectors for WatchDog Stations/Loggers/Pups (3665R, 3665RD)	3665BG		\$ 29.50
RADIATION SHIELD Protect your Micro Station or Data Logger from rain and measurement distorting solar radiation COMPATIBILITY: WatchDog Micro Stations and A-Series Data Loggers	3663		\$ 79.00
SLIDING ENCLOSURE Water resistant, mounts to pole or post COMPATIBILITY: WatchDog Micro Stations	3658A		\$ 55.00
WATERPROOF ENCLOSURE Clamshell enclosure COMPATIBILITY: WatchDog Micro Stations (Models 1400/1200 plus soil sensors)	3659WD1		\$ 110.00
ALARM OUTPUT MODULE Triggers an external device based on a sensor reading COMPATIBILITY: WatchDog 2000 Stations (Full and Mini)	3672		\$290.00



COMMUNICATION OPTIONS			
Item Description	Item #		Price
<p>WATCHDOG DATA SHUTTLE Transport weather data from your 2000 Series Weather Stations or 1000 Series Micro Stations to your host PC. Holds data for multiple stations (up to 5 Full, 10 Mini, or 12 Micro Stations). Includes soft-sided case (also available separately as Item #7500). Requires SpecWare Basic or Pro. COMPATIBILITY: WatchDog 1000 and 2000 Mini and Full Stations</p>	3679WD1		\$395.00
COMMUNICATION CABLES			
Item Description	Item #		Price
<p>DIRECT CONNECT CABLES (3000/2000 MODELS) Connect your WatchDog Weather Station directly to your PC with a 75' (22.8m) cable that has a 9-pin serial connection on PC end May require USB adapter (Item #3661U9) COMPATIBILITY: WatchDog 3500 and 2000 Stations and 3200 Stations shipped after 2/1/24</p>	3660DP (includes AC adapter)		\$155.00
<p>DIRECT CONNECT CABLES (3200 MODELS) Connect your WatchDog Weather Station directly to your PC with a 75' (22.8m) cable that has a 9-pin serial connection on PC end May require USB adapter (Item #3661U9) COMPATIBILITY: WatchDog Retrievers, 3200 Stations shipped prior to 2/1/24</p>	3927C75		\$139.00
<p>SHORT RANGE MODEM PAIR Use short range modems to maintain signal on wired connections up to 4,000' (1.2km) using a 9-pin serial connection on PC end May require USB adapter (Item #3661U9) COMPATIBILITY: WatchDog Retrievers, 3000 and 2000 Stations</p>	3365WD3		\$595.00
<p>USB TO 3.5MM STEREO PLUG ADAPTER Connect WatchDog and FieldScout devices directly to your computer's USB port COMPATIBILITY: WatchDog 2000 and 1000 Stations and most FieldScout Devices except TDR's and TruFirms</p>	3661U		\$ 79.00
<p>USB TO 9-PIN SERIAL ADAPTER Connect 9-pin serial cables (such as Item #3660-75SP) directly to your computer's USB port COMPATIBILITY: WatchDog Direct Connect Cables and Short Range Modem Pair</p>	3661U9		\$ 73.50

MEASURE & RECORD WIND SPEED WITH THE WATCHDOG PORTABLE WIND METER

Pesticides can be harmful...to us, to surrounding crops, plants or livestock.....anything within range of the spray area.

Complaints, crop damage and livestock loss are all possible without documentation of wind speed and direction at the time of spraying. Avoid drift complaints with the WatchDog Portable Wind Sensor! This measurement tool uses ultrasonic technology and bluetooth connection so you can see the conditions when you are ready to spray. Not only does it display the wind speed and direction real time via the app, but it provides you with the ability to email data logs to keep a record of conditions each time you spray!



2023-05-19 08:44:14 CDT	
Lat: 41.739416	Long: -88.228052
Wind Speed: 4.5 mph	Direction: 34° NE
Temperature: 63.8 °F	Humidity: 78%
Barometer: 29.93 in Hg	DeltaT: 4.6 °F
Device: EF:A7:78:9D:47:76	Battery: 20%

Log Record

USE THE FREE APP!



- Scan to download the WatchDog Wind app
- Follow the prompts to calibrate the compass on your phone
- Once calibrated, complete set up instructions and start recording data
- Email records directly from the app

NO MOVING PARTS

- Immediate and precise measurements
- Portable design for spot measurements

CREATE SPRAY RECORDS

- Choose data by a specific day or date range
- Email records directly from the app
- Make informed pesticide application decisions

AVOID NEGATIVE IMPACT FROM DRIFT

- Improve pesticide coverage on targeted area
- Ensure safety of surroundings
- Address legal issues with accurate, *time stamped* data

DEMONSTRATE GOOD STEWARDSHIP

Item #	Item Description	Price
3348P	WatchDog Portable Wind Sensor <i>(includes mounting bracket, wireless charger, wall plug and stabilizer)</i>	\$385.00

Product Specifications

<p>WIND SPEED: Range: 1 to 25m/s (2.24mph to 56mph) Accuracy: ±0.3m/s @ 10m/s (0.67mph @ 22.4mph)</p>	<p>WIND DIRECTION Range: 0° to 359° Accuracy: ±1°</p>
<p>ANEMOMETER DIMENSIONS: Diameter/Height: 1.69" (43mm) / 1.85" (47mm) Weight: 2.8oz (78g) Height with Phone Mount: 5.6" (144mm) Width with Phone Mount: 3.43" to 5.28" (87mm to 134mm) Phone Width Capacity: 2.28" to 4.13" (58mm to 105mm) Weight with Phone Mount: 5.4oz (152g)</p>	<p>MISCELLANEOUS: Sensors: 4 Ultrasonic Transducers Compatibility: WatchDog Wind App Power: Rechargeable Battery <i>(Qi Wireless Charger Included)</i> Battery Run Time: 150 Hours of Active Use IP Code: IPX8</p>

AVOID DRIFT COMPLAINTS WITH THE WATCHDOG SPRAYER STATION

Don't let misapplication of herbicides cost you. Let our sprayer station with an ultrasonic anemometer help you put pesticides ONLY where they belong.



Pesticide drift is increasingly important to commercial applicators. Accurate data helps pesticide applicators make important decisions regarding weather conditions that affect safety, drift and proper applications. With the WatchDog Sprayer Station, you can provide evidence of suitable conditions for pesticide application by logging your data. Mount the station directly on your equipment to monitor and log weather conditions on the go!

ALL IN ONE WEATHER STATION

Measure Wind Speed/Direction and Chill, Air Temperature, Barometric Pressure, Humidity and Dew Point. The WatchDog Sprayer Station computes true wind speed.

HOW DOES IT WORK?

- Continuously log your weather parameters at a user selectable rate or select the snapshot button on the console to capture current conditions at a specific moment
- Station uses an internal compass and GPS to adjust the wind sensor values by subtracting the vehicle speed and direction to compute the true values
- Handles adverse conditions with a UV stabilized, compact housing that is fully waterproof and resistant to chemicals

CHOOSE YOUR CONSOLE



WatchDog Sprayer Station Console



Raven Viper 4, ViperPro or Envizio Pro (not available through Spectrum)



AGCO Accu Terminal (not available through Spectrum)



Item #	Item Description	Price
3349SSCH	WatchDog Sprayer Station with Console <i>See data on the display and/or download directly from the console</i>	\$2,980.00
3349SSH	WatchDog Sprayer Station <i>Includes sensor unit with magnetic base, 21' (7m) cable with vehicle power and 9-pin serial connector integrates with Raven and AGCO controllers</i>	\$2,277.00
3349CN	WatchDog Sprayer Station Console <i>Includes console with built-in data logger, USB to 3.5mm stereo cable</i>	\$ 845.00
3349H	Replacement Humidity Sensor	\$ 225.00
3661U9	USB to 9-Pin Serial Adapter	\$ 73.50

Product Specifications	
WIND SPEED: Range: 0 to 90mph (0 to 145km/hr) Accuracy: <12mph (19km/h) = ±1.1mph (1.7km/h) or ±10% >12mph (19km/h) = ±2.3mph (3.7km/h) or ±5%	WIND DIRECTION Accuracy: 4 to 11mph (6 to 18km/h) = ±5° >12mph (19km/h) = ±2°
WIND RESOLUTION: Direction: 1° Speed: 0.1mph (0.2km/hr)	WIND ACCURACY TEMPERATURE RANGE: 32°F to 131°F (0°C to 55°C)
TEMPERATURE: Range: -13°F to 131°F (-25°C to 55°C) Accuracy: ±2°F (±1.1°C) with wind > 4.6mph (7.4km/h)	RELATIVE HUMIDITY: Range: 10% to 95% Accuracy: ±5% with wind > 4.6mph (7.4km/h)
BAROMETRIC PRESSURE: Range: 24in-Hg to 33in-Hg (800hPa to 1100hPa) Accuracy: ±0.029in-Hg (±1hPa)	



	ITEM #	ITEM DESCRIPTION	SpecConnect Compatible	LCD Display	Wireless	Evapotranspiration (ET)	Alarm Output Ready (Item #3672)	Temperature Sensor
3000 Series Wireless Stations	3550xx	ET Station (extra ports)	✓		✓	✓		✓
	3250xx	ET Station	✓		✓	✓		✓
	3540xx	Standard Station (extra ports)	✓		✓			✓
	3240xx	Standard Station	✓		✓			✓
	3230xx	Plant Growth Station	✓		✓			✓
	3230xxP	Plant Growth Station Pro	✓		✓			✓
	3230xxA	Plant Growth Station Aspirated	✓		✓			✓
	3220xx	Rain Station	✓		✓			✓
	3210xx	Frost Station	✓		✓			✓
	3580xx	Sensor Station	✓		✓			OPT
2000 Series Mini Stations	3686WDS	2475 Plant Growth Mini Station	✓	✓	OPT		✓	✓
	3684WD	2450 Frost Mini Station	✓	✓	OPT		✓	✓
	3683WD	2425 Temp Mini Station	✓	✓	OPT		✓	✓
	3685WD	2400 Sensor Mini Station	✓	✓	OPT		✓	
Retriever & Pups Wireless Network	3550DU	ET Pup Station	✓		✓	✓		✓
	3250DU	ET Pup Station	✓		✓	✓		✓
	3540DU	Standard Pup Station	✓		✓			✓
	3240DU	Standard Pup Station	✓		✓			✓
	3220DU	Rain Pup Station	✓		✓			✓
	3900PG	Plant Growth Pup Station	✓		✓			✓
	3900	Sensor Pup	✓		✓			OPT
	3902	Repeater Pup	✓		✓			
1000 Series Micro Stations	3685SM14	Irrigation Station		✓				
	3684PAR1	Plant Growth Station		✓			✓	✓
	3688WD1	1650 Frost Micro Station		✓			✓	✓
	3687WD1	1525 Temp Micro Station		✓			✓	
	3684WD1	1450 Frost Micro Station		✓			✓	✓
	3683WD1	1425 Temp Micro Station		✓			✓	
	3685WD1	1400 Sensor Micro Station		✓				
	3682WD1	1250 Frost Micro Station		✓			✓	✓
	3681WD1	1225 Temp Micro Station		✓			✓	
	3680WD1	1200 Sensor Micro Station		✓				
A-Series Data Loggers	3611A	A160 Temp/RH/CO ₂ Logger		✓			✓	✓
	3612A	A150 Temp/RH Logger		✓			✓	✓
	3610A	A130 Leaf Wetness/Temp Logger		✓			✓	
	3617A	A125 Soil/Air Temp Logger		✓			✓	
	3617ARS	A125 Soil/Air Temp Logger		✓			✓	
	3618A	A110 Temp Logger		✓			✓	
Sprayer Station	3349SSCH	Sprayer Station with Console		✓			✓	✓

Relative Humidity Sensor
Dew Point (Computed)
Wind Speed/Direction
Tipping Bucket Rain Collector
Solar Radiation Sensor (Item #3670)
Available Sensor Ports
Quantum Light Sensor (Item #3688S)
Exterior Soil Temperature Sensor (Item #3667)
Leaf Wetness Sensor (Item #3666)
WaterScout SM100 Sensor (Item #6460)
WaterScout SMEC300 Sensor (Item #6470-6)
Digital Sensor Compatible (*see compatibility, page 19)
Radiation Shield

✓	✓	✓	✓	✓	5	OPT	OPT	OPT	OPT	OPT	✓	P
✓	✓	✓	✓	✓	1	OPT	OPT	OPT	OPT	OPT	*	P
✓	✓	✓	✓	OPT	6	OPT	OPT	OPT	OPT	OPT	✓	P
✓	✓	✓	✓	OPT	2	OPT	OPT	OPT	OPT	OPT	*	P
✓	✓	OPT	OPT	OPT	1	✓	OPT	OPT	OPT	OPT	*	P
✓	✓	OPT	OPT	OPT	1	3688A	OPT	OPT	OPT	OPT	*	P
✓	✓	OPT	OPT	OPT	1	3688A	OPT	OPT	OPT	OPT	*	A
✓	✓	OPT	✓	OPT	2	OPT	OPT	OPT	OPT	OPT	*	P
✓	✓	OPT	OPT	OPT	2	OPT	OPT	OPT	OPT	OPT	*	P
OPT		OPT	OPT	OPT	8	OPT	OPT	OPT	OPT	OPT	✓	
✓	✓		OPT	OPT	1	✓	OPT	OPT	OPT	OPT		P
✓	✓		OPT	OPT	2	OPT	OPT	OPT	OPT	OPT		P
			OPT	OPT	3	OPT	OPT	OPT	OPT	OPT		P
			OPT	OPT	4	OPT	OPT	OPT	OPT	OPT		
✓	✓	✓	✓	✓	5	OPT	OPT	OPT	OPT	OPT	✓	P
✓	✓	✓	✓	✓	1	OPT	OPT	OPT	OPT	OPT	✓	P
✓	✓	✓	✓	OPT	6	OPT	OPT	OPT	OPT	OPT	✓	P
✓	✓	✓	✓	OPT	2	OPT	OPT	OPT	OPT	OPT	✓	P
✓	✓		✓	OPT	2	OPT	OPT	✓	OPT	OPT	✓	P
✓	✓	OPT	OPT	OPT	2	✓	OPT	OPT	OPT	OPT	✓	A
OPT		OPT	OPT	OPT	4	OPT	OPT	OPT	OPT	OPT	✓	P
					0							
					0				✓ (4)			
✓	✓				1	✓	OPT	OPT	OPT	OPT		P
✓	✓		OPT	OPT	4	OPT	OPT	OPT	OPT	OPT		
			OPT	OPT	4	OPT	OPT	OPT	OPT	OPT		
✓	✓		OPT	OPT	2	OPT	OPT	OPT	OPT	OPT		
			OPT	OPT	3	OPT	OPT	OPT	OPT	OPT		
			OPT	OPT	4	OPT	OPT	OPT	OPT	OPT		
✓	✓				0							
			OPT	OPT	1	OPT	OPT	OPT	OPT			
			OPT	OPT	2	OPT	OPT	OPT	OPT	OPT		
✓	✓				0					+CO ₂		
✓	✓				0							
					0			✓				
					0			✓				P
					0							
✓	✓	✓			0							

WHAT IS A TDR?

TDR, short for Time Domain Reflectometry, accurately measures soil moisture across a full range of soil conditions. With multiple rod length options to suit various root zones, the TDR can be used anywhere.

WHAT DOES A TDR MEASURE?

A TDR accurately measures soil moisture as volumetric water content % (VWC), electrical conductivity (EC/salts), and surface temperature. When the TDR is inserted into the soil, the sensor on the bottom plate measures the surface temperature. The rods send an electromagnetic wave through the surrounding soil. Some energy is absorbed into the soil and the rest reflects back, capturing VWC and EC and providing an instantaneous reading on the display.

WHAT ARE THE BENEFITS OF USING A TDR?

- Portable design for instant, accurate and actionable root zone VWC and EC readings
- Drives informed, data based decisions for irrigation scheduling, syringing practices and soil flushes
- Allows trend tracking to optimize soil health and conditioning
- Improve turf health and save on labor costs with more knowledge about the state of your course
- Increase crop yield and profits by providing your crops with the best growing conditions possible



WHAT ACCESSORIES ARE AVAILABLE?

- **Rods:** Multiple lengths are available for various root zones (1.5", 3", 4.8", 8")
Rods are required and sold separately. See page 28.
- **TDR Spacer:** Optional for use in TDR300 Mode* on all TDR Models when using 1.5" (3.8cm) rods to measure 0.5" (1.3cm) and 1" (2.5cm) depths. Ideal when you want to measure VWC close to the surface, especially on turf when firmness is important. *See page 28.*
**TDR300 Mode does not adjust VWC for EC*
- **Infrared Temperature Sensor:** Optional for use with TDR350/150 models
 - Predict turf wilt with higher accuracy
 - Correct a moisture deficit earlier and reduce heat stress
 - Quickly and accurately measure surface temperature
 - Use IR temperature for real time, instantaneous readings

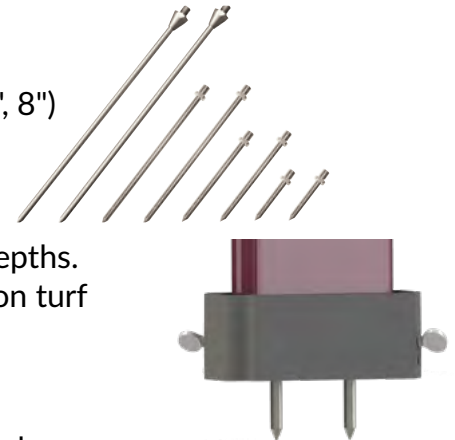

HOW DO I VIEW THE DATA?

Data viewing varies by TDR model and is an important factor to consider when choosing which one is the right fit.

Manual (TDR350/250/150): View readings on the TDR display screen. Download the raw data with a USB flash drive. No special software or cable is required.

Hands Free (TDR350/150): View data instantly as you take readings in the FieldScout App.

SpecConnect (TDR350/150): Add a SpecConnect FieldScout Pro subscription and all of your data is automatically sent to the cloud where you can view it in your personal web portal and take advantage of enhanced mapping and reporting features.



TDR350 - Measures VWC/EC/Surface Temperature

Our most robust model, the TDR350's ergonomic design allows you to adjust the height of the meter to suit you and avoid unnecessary bending.

Equipped with integrated Bluetooth and GPS, view real time data on the backlit display and in the FieldScout app as measurements are taken. With a SpecConnect FieldScout Pro subscription, data is automatically uploaded to your portal. The internal data logger records approximately 50,000 measurements with GPS coordinates.

VWC Range: 0% to Saturation, **Resolution:** 0.1%, **Accuracy:** ±3% VWC
EC Range: 0 to 5mS/cm, **Resolution:** 0.01mS/cm, **Accuracy:** ±0.1mS/cm
Temperature Range: -22°F to 140°F (-30°C to 60°C), **Resolution:** 0.2°F (0.1°C), **Accuracy:** ±1.8°F (1°C)
IR Temperature Range: 32°F to 140°F (0°C to 60°C), **Resolution:** 0.2°F (0.1°C), **Accuracy:** ±0.2°F (0.1°C)

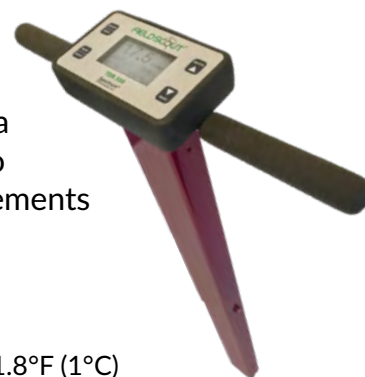

TDR150 - Measures VWC/EC /Surface Temperature

The TDR150 is a more compact meter, ideal for measuring plants in greenhouses and nurseries.

Equipped with integrated Bluetooth and GPS, view real time data on the backlit display and in the FieldScout app as measurements are taken. With a SpecConnect FieldScout Pro subscription, data is automatically uploaded to your portal. The internal data logger records approximately 50,000 measurements with GPS coordinates.

VWC Range: 0% to Saturation, **Resolution:** 0.1%, **Accuracy:** ±3% VWC
EC Range: 0 to 5mS/cm, **Resolution:** 0.01mS/cm, **Accuracy:** ±0.1mS/cm
Temperature Range: -22°F to 140°F (-30°C to 60°C), **Resolution:** 0.2°F (0.1°C), **Accuracy:** ±1.8°F (1°C)
IR Temperature Range: 32°F to 140°F (0°C to 60°C), **Resolution:** 0.2°F (0.1°C), **Accuracy:** ±0.2°F (0.1°C)



TDR250 - Measures VWC

The TDR250 offers the same technology with 20% less investment. The height of the meter cannot be adjusted with this model and it does not have Bluetooth and GPS integration.

View real time data on the backlit display as measurements are taken. The internal data logger records approximately 124,000 measurements. The device features a USB port to download the data.

VWC Range: 0% to Saturation, **Resolution:** 0.1%, **Accuracy:** ±3% VWC



Item #	Item Description	Price
6435	TDR350 Soil Moisture Meter With Carrying Case <i>Rods required but sold separately</i>	\$1,635.00
6250	TDR250 Soil Moisture Meter <i>Rods required but sold separately, carrying case sold separately</i>	\$1,310.00
6445	TDR150 Soil Moisture Meter With Carrying Case <i>Rods required but sold separately</i>	\$1,225.00

FieldScout TDR Soil Moisture Meter Product Options

28

View data on the **SpecConnect** web portal. See soil moisture readings at different points to know what areas require more irrigation. Manipulate the data with a variety of reporting options. See pages 52-53 for more information.

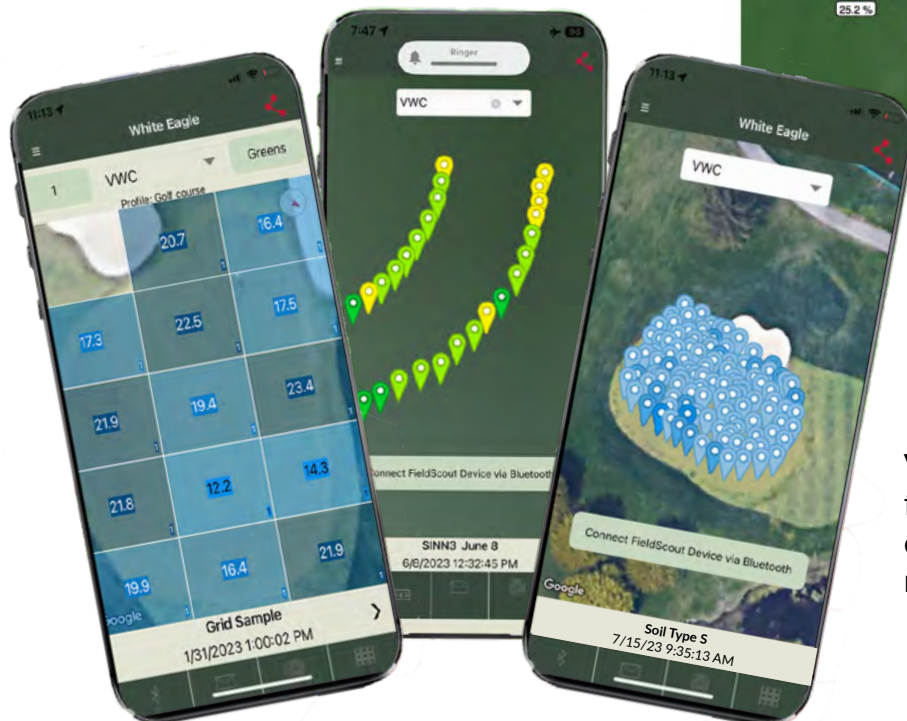
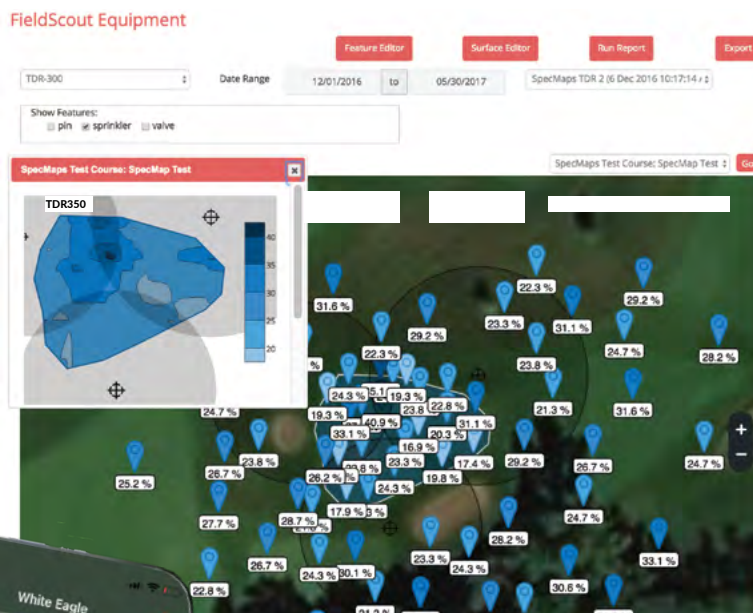

View data in the FieldScout App. Choose from Grid Mode or Freeform depending on what you are measuring and what method would be most beneficial to you.

Item #	Item Description	Price
6435	TDR350 Soil Moisture Meter With Carrying Case <i>Rods required but sold separately</i>	\$1,635.00
6250	TDR250 Soil Moisture Meter <i>Rods required but sold separately, carrying case sold separately</i>	\$1,310.00
6445	TDR150 Soil Moisture Meter With Carrying Case <i>Rods required but sold separately</i>	\$1,225.00
6430CASE	Carrying Case <i>Fits TDR250 and TDR350 Meters</i>	\$ 99.00
6428FS4	Two 1.5" (3.8cm) Rods	\$ 76.00
6429FS4	Two 3" (7.6cm) Rods	\$ 76.00
6431FS4	Two 4.8" (12cm) Rods	\$ 81.00
6432FS4	Two 8" (20cm) Rods	\$ 93.00
6430PH	Pilot Hole Maker for TDR Meters <i>Includes (2) 3" (7.6cm) Rods</i>	\$ 99.00
6435SP	Rod Spacer	\$ 62.00
6435TS	Infrared Temperature Sensor for TDR350	\$ 195.00
6445TS	Infrared Temperature Sensor for TDR150	\$ 195.00

WATERSCOUT SENSORS

Our two WaterScout soil moisture sensors are perfect options when you want data points at multiple soil depths to better determine irrigation needs.

29

WaterScout
Soil Moisture
Sensors

SM100 Soil Moisture Sensor

- Measures Volumetric Water Content (VWC%) of soil
- Capacitance type sensor that responds immediately to changes in soil moisture content
- Use in mineral soils or soil-less media
- Take spot measurements or install permanently



SMEC300 Soil Moisture Sensor

- Measures Volumetric Water Content (VWC%), Electrical Conductivity (EC) and Temperature of soil
- Capacitance type sensor that responds immediately to changes in soil moisture content
- WaterScout Calibration Device (Item #6470CAL3V) required unless using the Soil Sensor Reader (Item #6466) to view the data



HOW DO I VIEW THE DATA?

Sensors can be read with the FieldScout Soil Sensor Reader or in the WatchDog App when connected to a WatchDog 3000, 2000 or 1000 Series Station or a WatchDog Sensor Pup.



Item #	Item Description	Price
6460	WaterScout SM100 Sensor with 6' (1.8m) Cable	\$ 115.00
6460-20	WaterScout SM100 Sensor with 20' (6m) Cable	\$125.00
6470-6	WaterScout SMEC300 Sensor with 6' (1.8m) Cable	\$265.00
6470-20	WaterScout SMEC300 Sensor with 20' (6m) Cable	\$275.00
6470CAL3V	WaterScout EC Calibration Device	\$ 94.50
2251	Conductivity Standard, 1.41mS/cm, 250mL	\$ 31.00
6466	FieldScout Soil Sensor Reader	\$365.00

Product Specifications		
	WaterScout SM100	WaterScout SMEC300
Accuracy	3% VWC @ EC <8mS/cm	VWC: 3%, EC: ±2% Temperature: ±1°F (0.6°C)
Range	0% VWC to Saturation	VWC 0% to saturation, EC: 0 to 10 mS/cm, Temp: 33-175°F (0.5-80°C)
Temperature	NA	33°F to 175°F (0.5°C to 80°C)
Resolution	0.1% VWC	VWC: 0.1%, EC: 0.01mS/cm Temperature: ±1°F (0.6°C)
Power Requirements	3V to 5V @ 6mA to 10mA	3V @ 6mA to 10mA
Output	Analog Voltage 0.5V to 1.5V for a 3V Excitation <i>(ratiometric for other excitation voltages)</i>	Analog Voltage Time Division Multiplexed
Sensing Area	2.4" x 0.8" (2.4cm x 2cm)	2.25" x 0.75" (5.7cm x 2cm)

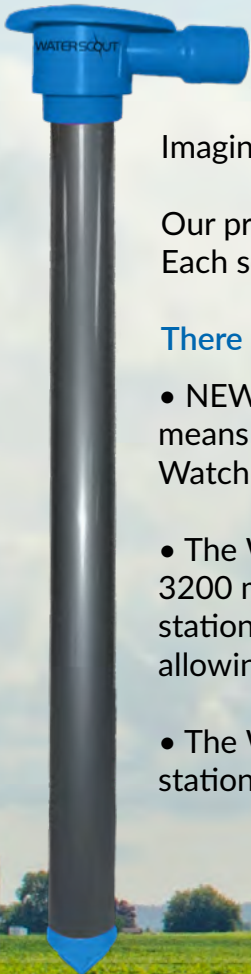

WATERSCOUT PROFILER

Imagine one probe with ALL the sensors you need already integrated!

Our profiler offers a variety of probe lengths, with differing numbers and depths of sensors. Each sensor depth measures both temperature and soil moisture.

There are three versions of the WaterScout Profiler:

- NEW! The WaterScout Wireless LoRa Profiler uses LoRaWAN technology for a cost-effective means to communicate soil moisture and temperature values to SpecConnect and the WatchDog Mobile app. SpecConnect subscription required.
- The WaterScout Profiler connects to all WatchDog Weather Station 3500 models and to 3200 models shipped after February 1, 2024. To soil moisture and temperature, the weather stations additionally offer Temperature, Humidity, Rainfall, Wind, and Solar Radiation (ET), allowing you to monitor all conditions simultaneously. SpecConnect subscription required.
- The WatchDog SDI-12 Profiler can be connected to most third-party data recorders and stations that support SDI-12 sensor input.

LoRa Wireless Profilers		Profilers for Weather Stations		Probe Length	# of Sensors	Sensor Depth Location Per Model (inches / mm)									
Item #	Price	Item #	Price			4" (100)	8" (200)	12" (300)	16" (400)	20" (500)	24" (600)	28" (700)	32" (800)	36" (900)	40" (1,000)
6022US915	\$785	6022	\$595	8" (200mm)	2	X	X								
6033US915	\$1045	6033	\$835	12" (300mm)	3	X	X	X							
6044US915	\$1150	6044	\$925	16" (400mm)	4	X	X	X	X						
6066US915	\$1360	6066	\$1095	24" (600mm)	6	X	X	X	X	X	X				
6048US915	\$1225	6048	\$980	32" (800mm)	4		X		X		X		X		
6068US915	\$1415	6068	\$1125	32" (800mm)	6	X	X	X	X		X		X		
6061US915	\$1465	6061	\$1155	40" (1000mm)	6	X	X		X		X		X		X
6011US915	\$1780	6011	\$1445	40" (1000mm)	10	X	X	X	X	X	X	X	X	X	X

Profiler Installation Augers: 29in (710mm) - \$75.00 or 44in (1120mm) - \$125.00

NEW! WaterScout Wireless LoRa Profiler

Using LoRaWAN technology, this is a cost-effective alternative to connecting to a WatchDog Weather Station to monitor soil moisture (VWC) and temperature.

- Makes irrigation scheduling easier, especially in arid regions
- LoRa Radio Communication provides signal up to 6km (3.5 miles) clear line of sight
- Indoor and Outdoor Gateways also available. A Gateway is required, but can be shared – there may already be one in your area.

Outdoor Cellular Gateway – Mount your Gateway high for the best coverage. Communicates via LTE-CAT4. SpecConnect subscription required.

Indoor Ethernet Gateway – Connects via CAT-5 Ethernet cable to your router. 50ft antenna cable included to enable elevated outdoor antenna mounting.

Item #	Item Description	Price
4900US915U	LoRa Cellular Gateway	\$895.00
4901US915	LoRa Indoor Gateway	\$495.00

LoRa Cellular Gateway



LoRa Indoor Gateway



**6066US915
WaterScout
LoRa Wireless
Profiler**

**3685SM13
WatchDog 1000 Series Micro
Station with Sliding Enclosure
and 3 WaterScout SM100 Sensors**

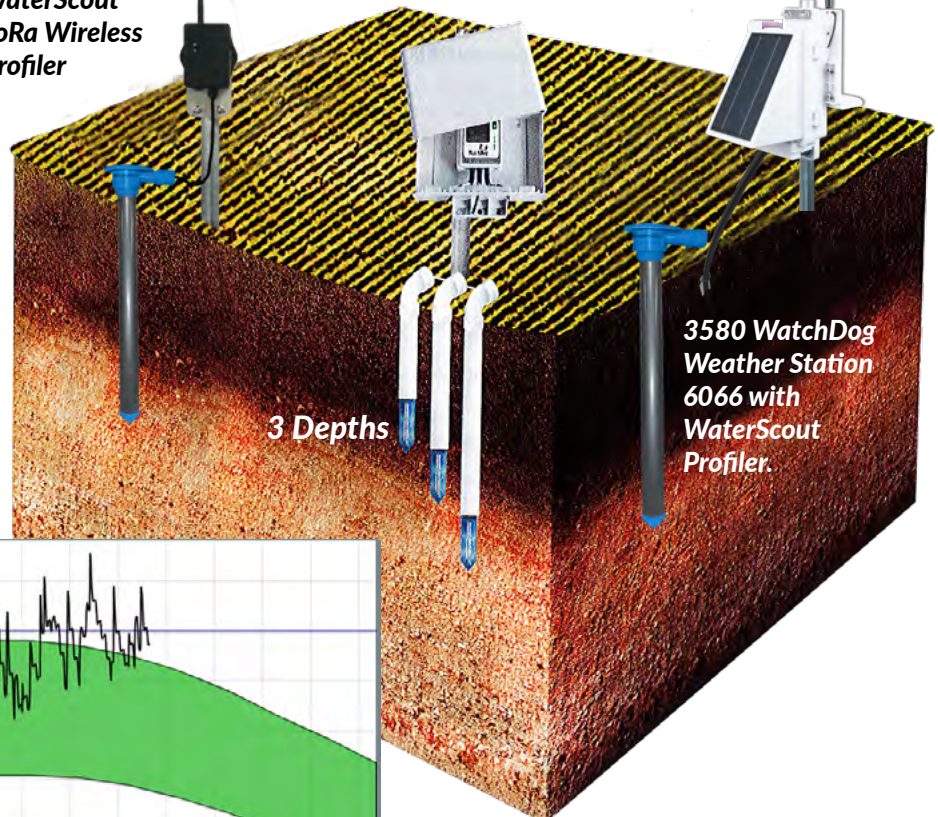

**3580 WatchDog
Weather Station
6066 with
WaterScout
Profiler.**

Soil Moisture Report



WATERMARK SOIL MOISTURE SENSOR

An economical way to measure soil moisture tension

- Compatible with WatchDog Weather Stations and the FieldScout Soil Sensor Reader
- Reads moisture tension from 0 (saturated) to 200 (dry) centibars

Item #	Item Description	Price
6450-20	Watermark Soil Moisture Sensor with 20' (6.0m) pigtail cable (not compatible with WatchDog Station)	\$ 59.50
6450WD	Watermark Sensor for WatchDog Station & Pups with 11' (3.3m) cable	\$ 99.75
6450WD20	Watermark Sensor for WatchDog Stations & Pups with 25' (7.6m) cable	\$125.00



Item #6450-20

IRROMETER TENSIO METERS

Schedule irrigation based on how hard plant roots are working to draw water from the soil

- "SR" Models (Items #6419 through 6423) are for general use with field or tree crops
- Low Tension (LT) models are for coarse soils or soil-less media
- Portable models for specialized applications
- Pressure gauge has a quarter inch pipe thread

Item #	Item Description	Price
6419	Tensiometer SR Model 6" (15cm) Depth	\$124.50
6420	Tensiometer SR Model 12" (30cm) Depth	\$128.50
6421	Tensiometer SR Model 18" (45cm) Depth	\$132.50
6422	Tensiometer SR Model 24" (60cm) Depth	\$139.50
6423	Tensiometer SR Model 36" (90cm) Depth	\$150.00
6425	Tensiometer Service Kit (REQUIRED)	\$ 86.85
9917	Tensiometer SR Model Tip Replacement	\$ 21.35



Item #6420

ECONOMY SOIL MOISTURE TESTER

Analog soil moisture meter measures any type of soil with just one calibration

- Resistance type sensor located at the tip of the shaft
- Provides instant results ranging from 0 (dry) to 10 (saturated)
- 3 month warranty

Item #	Item Description	Price
6400	Soil Moisture Tester 9" (22cm)	\$139.50
6405	Soil Moisture Tester 24" (60cm)	\$149.50



Item #6400

WHAT IS A DIRECT SOIL EC METER?

Electrical Conductivity (EC) is affected by salts in the soil. This measurement allows you to better understand the nutritional needs of your plants. It can indicate either a surplus or deficiency so you can take proper action to maintain healthy turf/crops/plants.

- Instant and accurate EC and temperature measurements
- Professional grade meter
- No need to prepare a slurry; sample directly in ground soil, plug trays, pots, containers or solutions
- Patented soil sensor tip design provides maximum contact and higher accuracy
- Reads 0 to 19.9mS/cm (Accuracy: $\pm 1\%$, Resolution: 0.01mS/cm)
- Automatic temperature compensation, long lasting, waterproof
- Includes battery and EC calibration standard

33

FieldScout
Direct Soil
EC Meter



FieldScout Direct Soil EC Meter
with 24" (60cm) T-Handle Sensor



Item #	Item Description	Price
2266FS	FieldScout Direct Soil EC Meter with 8" Probe (Includes carrying case and 2.76 Standard)	\$ 722.00
2266PROBE	FieldScout EC 8" Replacement Probe	\$ 446.25
2266FSTP	FieldScout Direct Soil EC Meter with 24" T-Handle Probe with Replaceable Tip (Includes carrying case and 2.76 Standard)	\$1,215.50
2266FST24P	FieldScout T-Handle EC 24" T-Handle Replacement Probe with Replaceable Tip	\$ 775.75
2266	FieldScout Replaceable Tip for EC 24" T-Handle Probe	\$ 157.00
2251	Conductivity Standard, 1.41mS/cm, 250mL	\$ 19.50

Exclusive Patented Paired Sensor



WHAT IMPACT DOES SOIL COMPACTION HAVE?

Soil compaction compresses soil particles, reducing the available air space, making the movement of water through the roots difficult. This inhibits the growth of plant roots, negatively affecting crops, plants, and turf health. Using a soil compaction meter helps guide decisions regarding areas of the field that require tillage, changes to crop rotation and planting of cover crops.

FIELDSCOUT SC900

- Includes 1/2" (1.3cm) and 3/4" (1.9cm) cone tip
- Takes compaction readings every inch from 0" to 18" (45cm)
- Exclusive ultrasonic depth sensor captures readings in 1" (2.5cm) increments
- Penetration resistance measured by internal load cell
- Compaction data is displayed in psi or kPa (1psi = 6.9kPa)
- Connects to any GPS receiver with a serial output option*
- Equipped with an internal data logger and RS-232 port
- Configure and download meter with FieldScout software (included)**
- Upload your data to SpecConnect for maps of compaction by depth or depth to hard pan layer
- Includes USB cable, carrying case and depth target

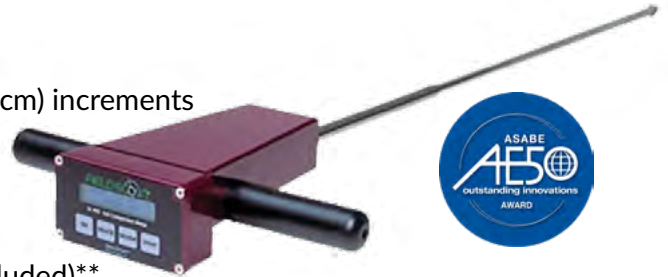

*GPS interface requires two cables: GPS/DGPS cable (Item #2950CV5) available from Spectrum and the PC serial interface cable supplied by the manufacturer of the GPS receiver

**PC cable connects to a computer USB port

Product Specifications	
Measurement Units	Cone Index (psi or kPa)
Resolution	1" (2.5cm), 5psi (35kPa)
Accuracy	±0.5" (1.25cm) Depth, ±15psi (103kPa) Pressure
Range	0 to 18" (0 to 45m), 0 to 1,000psi (0 to 7,000kPa)
Battery/Life	4 AAA Alkaline Batteries; Approximately 12-Month Life
Data Logger Capacity	772 Profiles without GPS, 579 Profiles with GPS



SOIL COMPACTION TESTER

- Economical way to measure soil compaction with analog readout
- Small and large tips included with convenient storage in tester housing
- 24" (60cm) stainless steel rod with adjustable shock collar to prevent damage to the gauge during transport or storage
- Easy to read, color-coded stainless steel dial is liquid filled to reduce shock
- Durable molded housing with rubber grip handles
- Penetration Depth: Up to 24" (60cm) in 3" (7.6cm) increments



Item #	Item Description	Price
FieldScout SC900 Soil Compaction Meter and Accessories		
6110FS	FieldScout SC900 Soil Compaction Meter	\$2,445.00
2950CV5	GPS/DGPS Cable	\$ 47.50
7250	GPS Unit Mounting Bracket	\$ 176.00
6106	1/2" (1.3cm) Replacement Tip (Fine Soils)	\$ 40.00
6107	3/4" (1.9cm) Replacement Tip (Coarse Soils)	\$ 45.00
Soil Compaction Tester		
6120	Soil Compaction Tester	\$ 245.00
6121	1/2" (1.3cm) Replacement Tip (Fine Soils)	\$ 27.50
6122	3/4" (1.9cm) Replacement Tip (Coarse Soils)	\$ 36.50

FIRM GREENS MEAN HAPPY GOLFERS!

Avoid soggy greens that prevent the ball from bouncing toward the putting green and make chip shots more difficult. Measure turf firmness and understand irrigation needs to firm up turf to ensure happy golfers will rave about your course!



The FieldScout TruFirm offers a quick, easy and affordable method to measure the firmness of turf, bunker sands and other playing surfaces. Data acquired from the device allows turf management professionals to measure the relationship between the compaction of the soil and the moisture level to quantify safety and performance of playing conditions. The TruFirm measures surface firmness/hardness (depth of impact in inches).

COMMON APPLICATIONS

- All-in-one portable meter for evaluating impacts of cultural practices, play and environmental conditions on putting greens and other athletic surfaces
- Perfect for golf course greens, approaches, bunker sands and fairway landing areas for achievement of optimal surface performance and consistency
- Useful on natural and artificial turf playing surfaces, infield dirt, turf and clay tennis courts, cricket pitches, bowling greens and racing tracks
- Track and trend data over time to better understand effects of turf inputs and optimize conditioning, playability and safety

FEATURES & BENEFITS

- Easy to Use - Simply raise and drop the hammer in one motion on the surface you are measuring and get immediate digital results on the device screen
- Mobile App - Compatible with the FieldScout app using bluetooth connection; add satellite mapping with automatic upload to the SpecConnect cloud with purchase of a SpecConnect FieldScout Pro license
- Objective Values - analyze and compare the impact of environmental and maintenance inputs on play
- Self Contained - all in one unit, easy to carry
- Affordable - add TruFirm to your toolbox with confidence

HOW DO I VIEW THE DATA?

Hands Free: View data instantly as you take readings on the FieldScout App

SpecConnect: Add a SpecConnect FieldScout Pro subscription and all of your data is automatically sent to the cloud where you can view it in your personal web portal and take advantage of enhanced mapping and reporting features.

Item #	Item Description	Price
6490S	FieldScout TruFirm Turf Firmness Meter	\$1,445
Product Specifications		
Diameter of Hammer	1.68" (4.45cm)	
Measurement Units	Depth of Travel (inches)	
Resolution	0.01" @ 1" to 1.5" (0.3mm @ 25.3mm to 38.1mm)	
Range	0.1" to 1.5" (2.5mm to 38.1mm)	
Battery	2AA Batteries (included)	
Height	27" (69cm)	
Weight	4.3lb (1.95kg)	

35

FieldScout TruFirm
Turf Firmness
Meter



TruFirm is a registered trademark
of the United States Golf Association



WHY MEASURE LIGHT?

While water is of key importance to the health and heartiness of plants, it is easy to overlook the impact of light. The amount of light a plant receives can vary significantly based on time of day, location and when/if a shade cloth or white wash is being utilized.

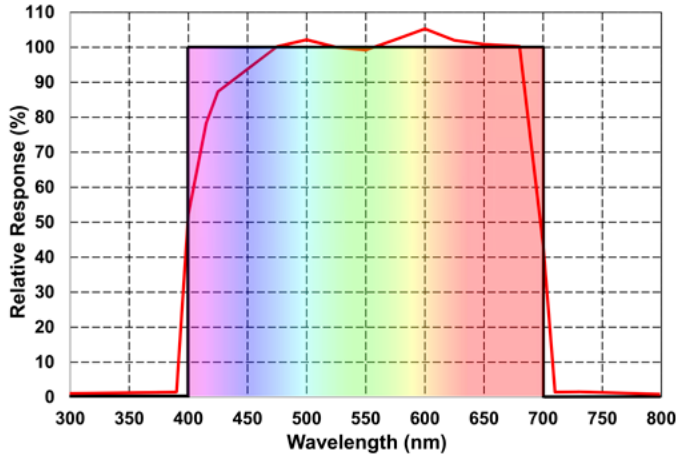

FULL SPECTRUM QUANTUM PAR LIGHT SENSORS/METERS

These sensors accurately measure light intensity across the full PAR (Photosynthetic Active Radiation) spectrum, including LED lights

- Integrates multiple optical detector elements to accurately measure light across the entire PAR spectrum from all light sources, including narrowband LED
- Perfect for all artificial light installations as well as locations supplementing natural light with LED's

Light transmission loss can be 40%-70% from outside to inside a greenhouse. Add in the timing of pulling shade cloth and the loss can be even greater. If you don't measure how much light your plants are receiving, they will not achieve their quality and profit potential!

<p>LightScout Full Spectrum Quantum PAR Light Sensor</p> <p><i>Plug sensor into any compatible WatchDog 3000 or 2000 Station/Pup</i></p> <p><i>Use with the LightScout External Light Sensor Meter (Item #3415FX)</i></p>		<p>Item #3668A - \$445.00</p>
<p>LightScout Full Spectrum Quantum PAR Light Meter with Internal Sensor</p> <p><i>Measure PAR light outside, inside, or at the bench</i></p>		<p>Item #3415Z - \$135.00</p> <p><i>(Includes soft sided carrying case and 2 AAA batteries)</i></p>
<p>LightScout Full Spectrum Quantum PAR Light Meter with External Sensor</p> <p><i>Ideal for measuring PAR light in vertical farms or hanging baskets.</i></p> <p><i>Includes 4.9' (1.5m) coiled cable for handheld measurements as well as a selfie stick with a 12' (3.7m) straight cable to extend your measuring reach</i></p>		<p>Item #3415ZX - \$145.00</p> <p><i>(Includes hard shelled plastic case and AAA batteries)</i></p>

DLI LIGHT METERS

The daily light integral (DLI) measures the total amount of PAR within a 24-hour period. Grow healthier, greener plants by measuring their precise light intake.

QUANTUM PAR/DLI LIGHT METER

- Provides accurate PAR light reading from ANY light source
 - Full sun to full shade, indoors or outdoors
 - Artificial light sources (LED, High Pressure Sodium, Metal Halide, Fluorescent, Halogen, etc)
- Three modes of operation
 - Instant spot measurement mode for PAR light readings
 - Scan mode for quickly averaging PAR over an area
 - DLI mode shows Daily Light Integral on the LCD display (*no computer needed*)



Item #3415A

- Integral mounting plate for stand, stake, lanyard hanger hold and magnet mounts
- 1/4" - 20" (0.64cm to 50.8cm) threaded hole for mounting on camera tripod/stand
- Includes sensor cover and soft-sided case

Generalized Plant Responses to Different Light Levels

Relative Light Level	DLI* Daily Light Integral	Light Intensity** at Noon	Generalized Plant Growth Response
Very Low	2 to 5	100 to 200	Poor Quality
Low	5 to 10	200 to 400	Minimum Acceptable
Medium	10 to 20	400 to 800	Good Quality
High	20 to 30	800 to 1,200	Excellent Quality
Very High	33 to 60	1,200 to 2,000	Excellent Quality

*Moles/Day

**Micromoles ($\mu\text{mol}/\text{m}^2 \cdot \text{s}^{-1}$)

NOTE: It is not possible to make a direct conversion between an instantaneous light measurement and the Daily Light Integral. Temperature is a key factor in plant quality and growth.

SOURCE: Hamrick, Debbie, ed. Ball Red Book - Batavia, IL: Ball Publishing, 2003



Item #3405

DLI100 LIGHT METER

- Affordable and simple, one button operation
- Meter runs for 24 hours to calculate DLI
- Real-time intensity levels are shown in $\mu\text{mol}/\text{m}^2 \cdot \text{s}^{-1}$ every 4 seconds daily
- Battery included
- Greenhouse or Turf models available

Item #	Item Description	Price
3415A	LightScout Quantum PAR/DLI Light Meter	\$349.00
3405G3	LightScout DLI100 Light Meter (Greenhouse, Set of 3)	\$169.00
3405G	LightScout DLI100 Light Meter (Greenhouse, 1 Unit)	\$ 59.00
3405T3	LightScout DLI100 Light Meter (Turf, Set of 3)	\$169.00
3405T	LightScout DLI100 Light Meter (Turf, 1 Unit)	\$ 59.00

	<p>EXTERNAL LIGHT SENSOR READER</p> <ul style="list-style-type: none"> • Plug in a sensor, choose it on the LCD screen and measure UV, Quantum Light or Solar Radiation • Reads any of Spectrum's external light sensors <i>(see page 19 for light sensor options)</i> 	<p>Item #3415FX - \$364.00</p>
	<p>RED/FAR-RED METER</p> <p>Red/Far-Red light ratio helps plants determine proximity to each other, affecting how tall or full they grow</p> <ul style="list-style-type: none"> • Cost effective • Displays the Red/Far-Red ratio on the LCD screen • Press a button to display 660nm and 730nm readings • Includes soft-sided case 	<p>Item #3412 - \$1,250.00</p>
	<p>UV METER</p> <p>Monitors critical UV radiation (250nm-400nm)</p> <ul style="list-style-type: none"> • Determine UV filtering capacity of greenhouse shades and glass barriers • Range is 0 to 200$\mu\text{mol}\cdot\text{m}^{-2}\cdot\text{s}^{-1}$ 	<p>Item #3414F - \$329.00</p> <p>Item #7500 Soft-Sided Carrying Case - \$39.50</p>
	<p>FOOT-CANDLE METER</p> <ul style="list-style-type: none"> • Displays immediate light level in units of foot-candles • Affordable light measurement solution with precision photodiode 	<p>Item #3413F - \$311.00</p> <p>Item #7500 Soft-Sided Carrying Case - \$39.50</p>

WHAT IS A SPAD METER?

A SPAD meter is a compact measurement tool used to determine the amount of chlorophyll in plant leaves without damaging them. Knowing a plant's chlorophyll content can help determine when fertilizer is needed. Understanding nutrient levels makes growing consistent, healthy plants easier so you can increase both yield and quality.

The SPAD meter is traditionally used by researchers and growers as a quick method for taking measurements. It can be used on a wide variety of plants and crops. Simply insert the leaf into the measurement head to take an instant reading that displays on the LED screen.



SPAD 502 PLUS CHLOROPHYLL METER

- Instantly measures chlorophyll content or "greenness" of your plants on a scale of -9.9 to 199
- Non-invasive, non-destructive measurement (leaf remains intact and can be remeasured throughout the growing process)
- Trend graph stores and displays up to 30 measurements
- Water resistant design (IPX4)
- Compare in-field SPAD readings to university guidelines
- Research shows a strong correlation between SPAD measurements and leaf nitrogen content
- Available with or without a built-in data logger
- Includes hard carrying case at batteries

SPAD DATA LOGGING MODEL

ALL THE FEATURES OF THE SPAD 502 PLUS METER AND

- Connect to any GPS receiver that has a serial output option*
- Equipped with an internal data logger and RS-232 port
- Records 4,096 measurements (1,488 with added GPS/DGPS option)
- Download FieldScout software from our website

Product Specifications

Optical Density Difference at Two Wavelengths	650nm and 940nm
Measurement Area	3/32" x 1/8" (2mm x 3mm)
Light Source	2 LED's
Receptor	Silicon Photodiode
Power Source	2 AA Alkaline Batteries (1.5V)
Repeatability	Within ± 0.3 SPAD Unit
SPAD Value	Index of Relative Chlorophyll Content, -9.9 to 199

*GPS interface requires two cables. The GPS/DGPS cable (Item #2950CV5) is available from Spectrum.

A PC serial interface cable supplied by the manufacturer of the GPS receiver is also required.

**PC cable connects to a computer USB port. Geo-referenced data can be uploaded to SpecConnect for mapping.

Item #	Item Description	Price
2900P	Minolta SPAD 502 Plus Chlorophyll Meter (basic version, no data logger)	\$2,895.00
2900PDL	Minolta SPAD 502DL Plus Chlorophyll Meter with RS-232 data port and built in data logger (includes software and USB PC cable)	\$3,460.00
2950CV5	GPS/DGPS Cable	\$ 47.50

WHY MEASURE CHLOROPHYLL & NDVI?

A greener appearance ensures the plant or turf is receiving the right amount of light and is healthy and fruitful. Measure these values to understand plant health and make any maintenance changes.

CM1000 CHLOROPHYLL METER

- "Point-and-shoot" technology to instantly measure red (700nm) and near infrared (840m)



CM1000 NDVI METER

- "Point-and-shoot" technology to instantly measure red (660nm) and near infrared (840nm) spectral bands
- Detects stress earlier than visual monitoring



- Laser guides outline the edges of the measured sample area
- Calculates and displays a running average for multiple readings
- Connects to any GPS receiver that has a serial output option
- Internal data logger/RS-232 port (requires software) records 3,250 measurements (1,350 with GPS/DGPS)
- Configure and download meter with FieldScout software
- Includes hard carrying case and batteries

TCM500 NDVI TURF COLOR METER

- Measures reflected light from approximately a 3" (7.6cm) diameter section of turf grass
- Uses an internal light source to negate the effect of sunny vs. cloudy conditions
- Measures reflectance in the red (660nm) and near infrared (850nm) spectral bands
- Displays results as NDVI, percent reflectance or as a user adjustable grass index from 1 to 9
- Connects to any GPS receiver that has a serial output option
- Internal data logger/RS-232 port (requires software) records 3,250 measurements (1,350 with added GPS/DGPS)
- Configure and download meter with FieldScout software
- Includes hard carrying case, batteries and TCM500 T-Handle (Item #2975H)



Product Specifications - TCM500	
Measurement System	Reflectance of Red (660nm) and NIR (850nm) light
Measurement Area	Approximately 3" (7.6cm)
Measurement Units	% Reflectance (0-99.9%) of red and NIR NDVI (0-1.000); Grass Index (1.00-9.00)
Power Source	1.9V alkaline battery (included) Approximately 3,000 measurements
Repeatability	±5% of measurement

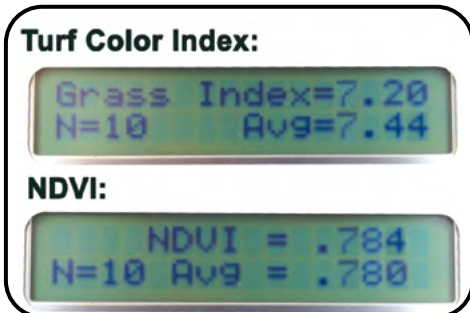

Item #	Item Description	Price
2950	FieldScout CM1000 Chlorophyll Meter	\$3,825.00
2953	FieldScout CM1000 NDVI Meter	\$3,945.00
2975NDVI	FieldScout TCM500 NDVI Turf Color Meter	\$1,395.00
2950CV5	GPS/DGPS Cable	\$ 47.50

MEASURE pH AND EC WITH ONE PROBE FOR CONSISTENT PLANT QUALITY

Soil pH/EC levels can vary in plants but tracking their levels to ensure they are in optimal range and are receiving the appropriate nutrients will give you better looking plants and help reduce shrinkage.

FIELDSCOUT WIRELESS ISFET pH/EC PROBE

Our NEW Wireless pH/EC Probe is available with a blunt or pinpoint tip probe. With wireless bluetooth connection and step by step instructions in the FieldScout pH/EC app, taking measurements is simple!

- Sample directly in plug trays, pots, containers, solutions and soil-less media
- ISFET non-glass electrode is stored dry
- Probes are interchangeable and replaceable
- Connect to mobile device via Bluetooth
- Receive notifications when pH or EC value is out of range



Item #	Item Description	Price
2127WE	FieldScout Wireless Blunt ISFET pH/EC Probe (includes hard case, transmitter, blunt tip probe, pre-drill stick, wireless charging station, pH 4, pH 7 and conductivity buffer solutions)	\$1,400.50
2128WE	FieldScout Wireless Pinpoint ISFET pH/EC Probe (includes hard case, transmitter, blunt tip probe, pre-drill stick, wireless charging station, pH 4, pH 7 and conductivity buffer solutions)	\$1,455.00
2127W	FieldScout Wireless Blunt ISFET pH Probe (includes hard case, transmitter, blunt tip probe, pre-drill stick, wireless charging station, pH 4 and pH 7 buffer solutions)	\$1,128.75
2128W	FieldScout Wireless Pinpoint ISFET pH Probe (includes hard case, transmitter, blunt tip probe, pre-drill stick, wireless charging station, pH 4 and pH 7 buffer solutions)	\$1,149.75
2127RE	FieldScout Wireless Blunt pH/EC Probe Replacement	\$ 579.00
2128RE	FieldScout Wireless Blunt pH/EC Probe Replacement	\$ 632.00
2127R	FieldScout Wireless Blunt pH Probe Replacement	\$ 577.80

Product Specifications	
Connection	BLE (Bluetooth Low Energy) wireless connection to mobile device
ATC (Auto Temperature Correction)	Yes
Dimensions	8.8" x 1.0" x 0.8" (224mm x 24.2mm x 20mm)
Probe Material	ABS/PEEK/Stainless Steel
Probe Length	5.0" (128mm)
Data Storage	Transmitter stores data when mobile device is disconnected
Operating/Storage Temperature	32°F to 176°F (0°C to 80°C) and 30% to 80% RH
pH	Sensor: Glass Free Ion Sensitive Field Effect Transistor (ISFET) Semiconductor Range: 0.00-14.00 Accuracy: ±0.02 Resolution: 0.01 Calibration: 1-, 2-, 3-, 5- point
EC	Sensor: 4 Electrode EC Sensor Range: 50-111,800µS/cm Calibration: At Factory/1 Point Calibration Accuracy within 1%: 50-12,880µS/cm, Resolution: 0.5µS/cm Accuracy within 10%: 50-111,800µS/cm, Resolution: 50nS/cm
TEMP	Sensor: NTC Range: 32°F-176°F (0°C-80°C) Accuracy: 1% Resolution: 0.1°F (0.1°C)
ORP	Range: -2,000 - 2,000mV Accuracy: ±0.2mV Resolution: 01mV Calibration: At Factory

LAQUAtwin

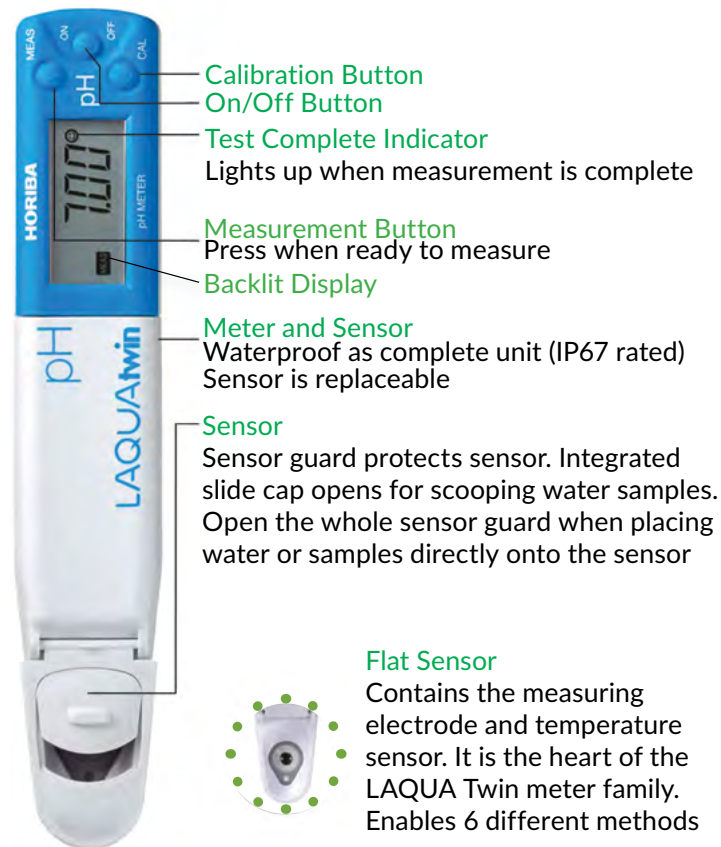

PUT THE POWER OF A LABORATORY IN YOUR HANDS

- Professional grade meters
- Measure samples in nutrient solutions, water, soils and tissue sap
- Waterproof pocket-sized meter with digital calibration
- Sensors store dry and are field replaceable
- Accuracy correlates well with laboratory analysis
- Unique flat sensor allows you to conveniently and accurately measure samples as small as 0.3mL
- Automatic temperature compensation, waterproof, auto power-off
- Includes two CR2032 batteries, case and calibration standards

DON'T WAIT, GET IMMEDIATE RESULTS TO MAKE CHANGES TO IMPROVE PLANT GROWTH!



pH Conductivity (EC) Sodium Potassium Nitrate Calcium

Measurement Principle:	Glass Electrode Method	2 AC Bipolar	Ion Electrode Method	Ion Electrode Method	Ion Electrode Method	Ion Electrode Method
Sample Volume Required	0.1 mL to 2.0 mL	0.12 mL to 2.0 mL	0.3 mL to 2.0 mL	0.3 mL to 2.0 mL	0.3 mL to 2.0 mL	0.3 mL to 2.0mL
Measurement Range	0 to 14 pH	0 to 199.9 mS/cm	2 to 9900 ppm	4 to 9900 ppm	6 to 9900 ppm	4 to 9900 ppm
Calibration	pH 4 and pH 7	1.41 mS/cm	150 ppm & 2000 ppm*	150 ppm & 2000 ppm*	34 ppm & 450 ppm*	150 ppm & 2000 ppm*
Reproducibility	± 0.1 pH	± 2%	± 10% or ± 10 ppm	± 10% or ± 10 ppm	± 10% or ± 10 ppm	± 20% or ± 20 ppm
Display	4-digit digital Backlit LCD Display					
Power	CR2032 Coin Batteries (x2)					
Battery Life	400 Hours Continuous Operation with Backlit Display Off (New)					
Operating Range	40°F (5°C) to 105°F (40°C), 85% Relative Humidity					
Dimensions	164mm x 29mm x 20mm					

*High and low calibration points can be changed (customer must provide custom solutions)

LAQUA Twin pH Meter		
2103ALP	LAQUA Twin pH Meter <i>(Includes Case, Batteries and pH 4 and 7 Standards)</i>	\$196.00
2143L	LAQUA Twin pH Replacement Sensor	\$131.00
2110	Refill Solutions pH 4 and 7, 60mL each	\$ 44.00
2135L	Sampling Sheets, 100 Pieces	\$ 98.50
LAQUA Twin EC Meter		
2205LP	LAQUA Twin EC Meter <i>(Includes Case, Batteries and pH 4 and 7 Standards)</i>	\$196.00
2242L	LAQUA Twin EC Replacement Sensor	\$140.00
2210L	Conductivity Standard, 1.41mS/cm, (6) 14mL Bottles	\$ 69.00
LAQUA Twin Sodium (Na ⁺) Meter		
2500GL	LAQUA Twin Sodium (Na ⁺) Meter <i>(Includes Case, Batteries and Calibration Standards)</i>	\$467.75
2540L	LAQUA Twin Sodium (Na ⁺) Replacement Sensor	\$216.00
2514L	150ppm Na ⁺ Standard, (6) 14mL Bottles	\$ 64.50
2518L	2,000ppm Na ⁺ Standard, (6) 14mL Bottles	\$ 64.50
2135L	Sampling Sheets, 100 Pieces	\$ 98.50
LAQUA Twin Potassium (K ⁺) Meter		
2400GL	LAQUA Twin Potassium (K ⁺) Meter <i>(Includes Case, Batteries and Calibration Standards)</i>	\$467.75
2440L	LAQUA Twin Potassium (K ⁺) Replacement Sensor	\$214.00
2414L	150ppm K ⁺ DI Standard, (6) 14mL Bottles	\$ 64.50
2418L	2,000ppm K ⁺ DI Standard, (6) 14mL Bottles	\$ 64.50
2135L	Sampling Sheets, 100 Pieces	\$ 98.50
LAQUA Twin Nitrate (NO ₃ ⁻) Meter		
2305GL	LAQUA Twin Nitrate (NO ₃ ⁻) Meter <i>(Includes Case, Batteries and Calibration Standards)</i>	\$467.75
2345L	LAQUA Twin Nitrate (NO ₃ ⁻) Replacement Sensor	\$216.00
2311	450ppm NO ₃ ⁻ -N Standard, (6) 14mL Bottles	\$ 99.00
2312	34ppm NO ₃ ⁻ -N Standard, (6) 14mL Bottles	\$ 99.00
2330	NO ₃ ⁻ Soil Test Kit, 30 Samples <i>(Includes Solutions, Filter Paper, Cups and Soil Scoop)</i>	\$ 275.00
2135L	Sampling Sheets, 100 Pieces	\$ 98.50
LAQUA Twin Calcium (CA ²⁺) Meter		
2450L	LAQUA Twin Calcium (CA ²⁺) Meter <i>(Includes Case, Batteries and Calibration Standards)</i>	\$532.25
2455L	LAQUA Twin Calcium (CA ²⁺) Replacement Sensor	\$216.00
2460L	150ppm CA ²⁺ DI Standard, (6) 14mL Bottles	\$ 64.50
2461L	2,000ppm CA ²⁺ DI Standard, (6) 14mL Bottles	\$ 64.50
2135L	Sampling Sheets, 100 Pieces	\$ 98.50





Our WatchDog Weather Stations can be configured in the WatchDog Mobile App!

Download the FREE app when you receive your weather station and start recording measurements immediately!



WatchDog Mobile Features

- Connect to your weather station via Bluetooth within the app
- Configure station to log data at your chosen intervals
- View and rename included sensors
- Connect additional sensors as desired in available ports
- View Current Conditions real time from anywhere
- Graph data from each sensor to view trends
- When subscribed to the alerts function, set alerts for instant notification
- Run reports within the app
- Send data directly to SpecConnect for additional reporting capabilities



View all of your connected WatchDog Equipment

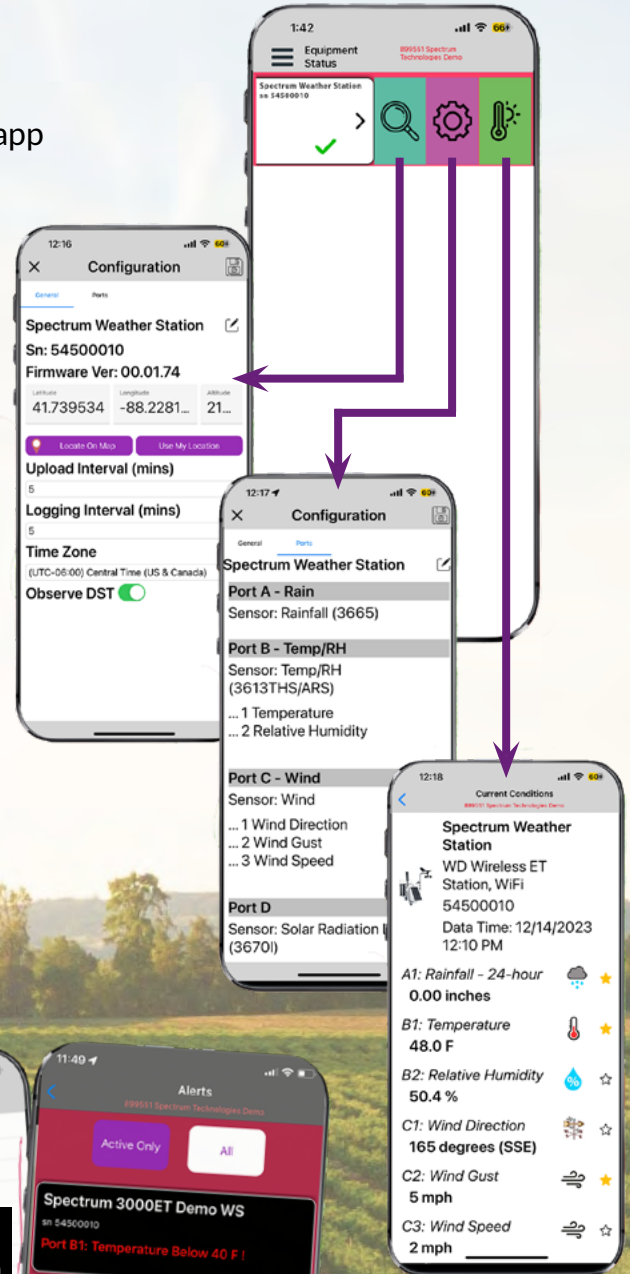

Click on a sensor icon to view a cumulative graph of that condition

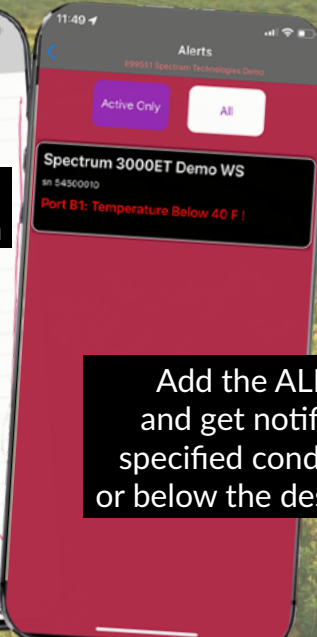

Add the ALERTS function and get notifications when a specified condition goes above or below the designated threshold

Our FieldScout TDR and TruFirm meters can be used with the FieldScout Mobile App!

Download the FREE app!



FieldScout Mobile Features

- Handsfree data collection
- The FieldScout Basic app allows you to take measurements in grid format
- Purchase a SpecConnect Pro subscription to take freeform measurements and see geo-referenced data points overlaid on your property
- Color coded data points to represent a scale of moisture, EC, surface temperature or turf firmness
- Map sprinkler heads, holes, pin locations and more
- Automatic wireless upload to SpecConnect for further analysis from your personal web portal

TDR soil moisture data plots on a golf course using both the FREEFORM and GRID mode.

Views data in SpecConnect for more detailed information and reporting.

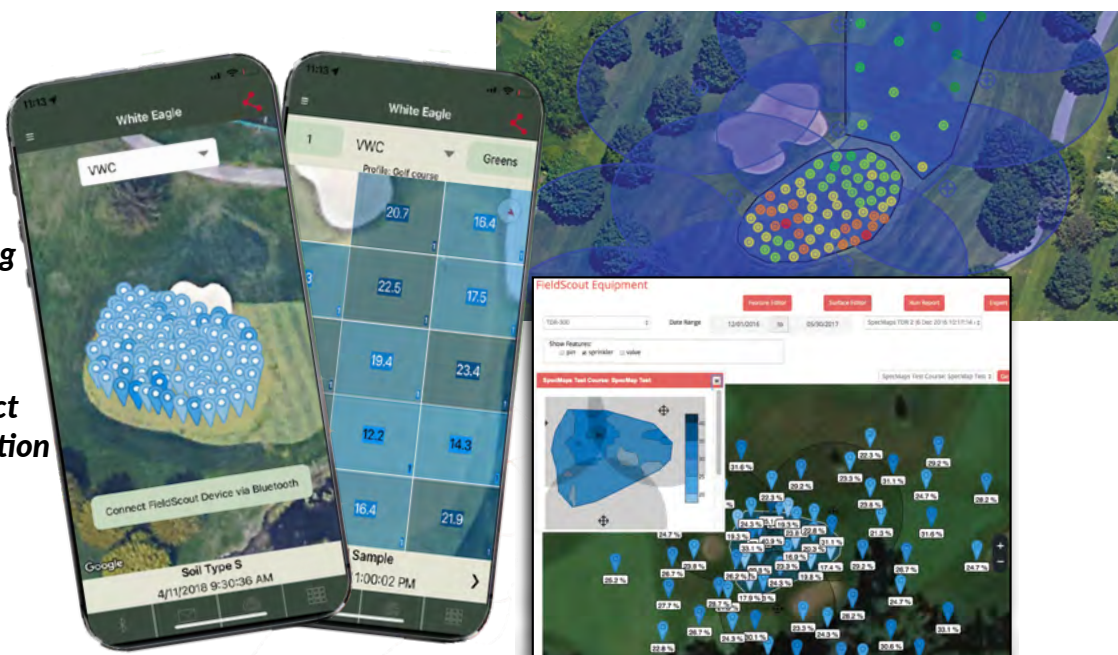

TDR in FREEFORM mode in a field of row crops. Pin colors can be changed to suit your preference.



TruFirm turf firmness measurements in GRID mode on a golf course.

When real time data viewing isn't necessary but data reporting is still needed, SpecWare Software is the answer!

SpecWare provides a permanent record of your data and allows you to view data from multiple WatchDog products within the system. Choose from the Basic or Pro version based on what equipment you are using and what information you need from your collected data. Gain back valuable time in your day by letting SpecWare do the data crunching!



SpecWare BASIC is the right choice if you are using a WatchDog Plant Growth Mini Station, a 1000 Series Micro Station, or any of our A or B Series Data Loggers.

If basic data is all you need to accomplish your goals with data analyzing, SpecWare Basic will meet your needs. Download the data via USB or direct connection to your PC and import into the SpecWare program. Quickly view standard reports from the data collected.

View multiple WatchDog products within the SpecWare program with one software purchase.



SpecWare PRO is the right choice if you are using a WatchDog 3000 Series Data Recorder, the WatchDog Pup/Retriever Mesh Network System, a WatchDog 2000 Series Station, a WatchDog Plant Growth Mini Station, a 1000 Series Micro Station, or any of our A or B Series Data Loggers.

If you want to build your own custom reports to suit your needs, if you want to view Evapotranspiration (ET) or if you want to add Insect or Disease models, SpecWare Pro will provide you with the analytics needed. Download the data via USB or direct connection to your PC and import into the SpecWare program.

View multiple WatchDog products within the SpecWare

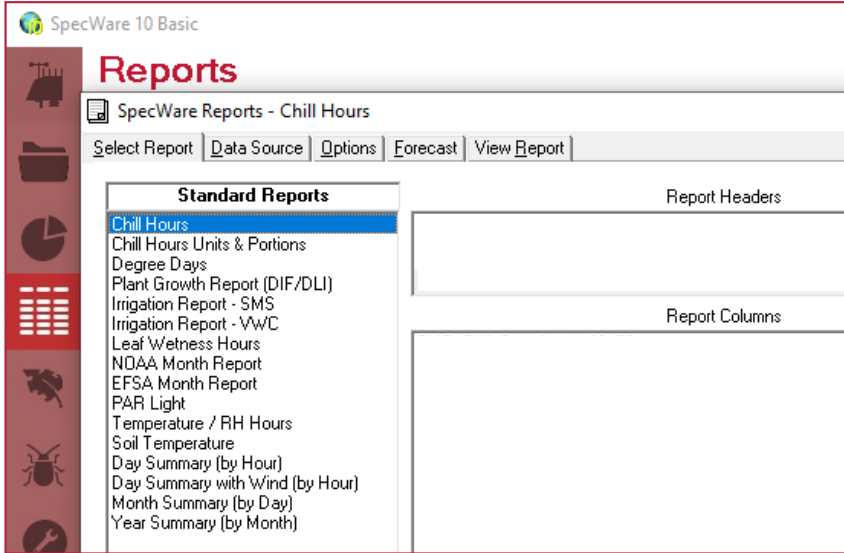

Choose from 16 available STANDARD reports when using SpecWare BASIC

Example of a Degree Days Report available as a STANDARD report using SpecWare BASIC

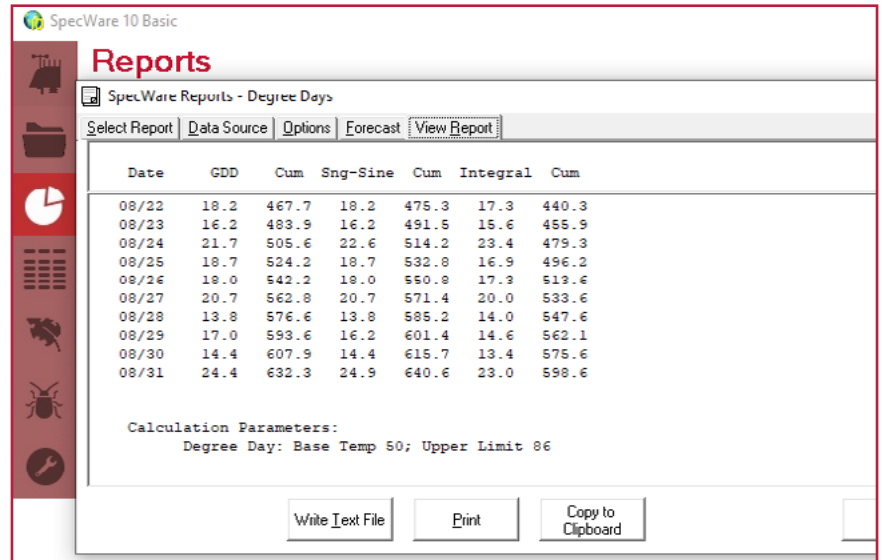

Example of Month Summary by Day Report available as a STANDARD report using SpecWare BASIC

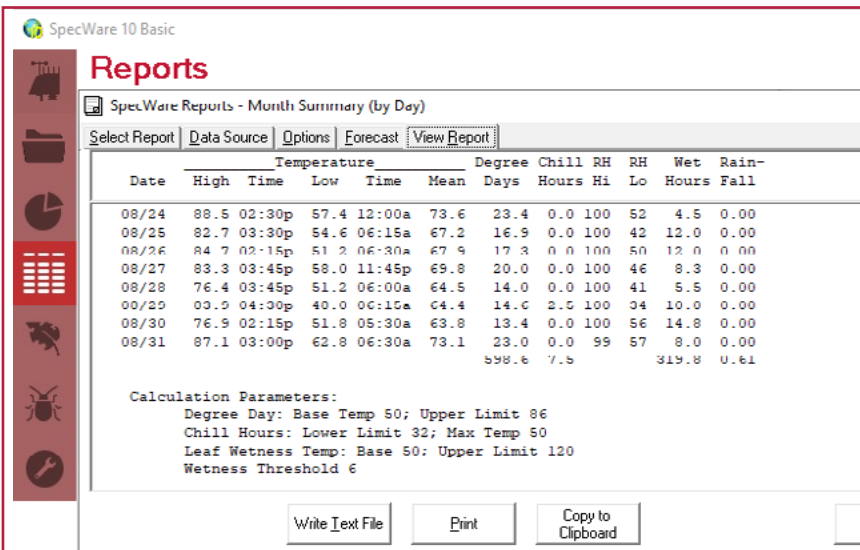

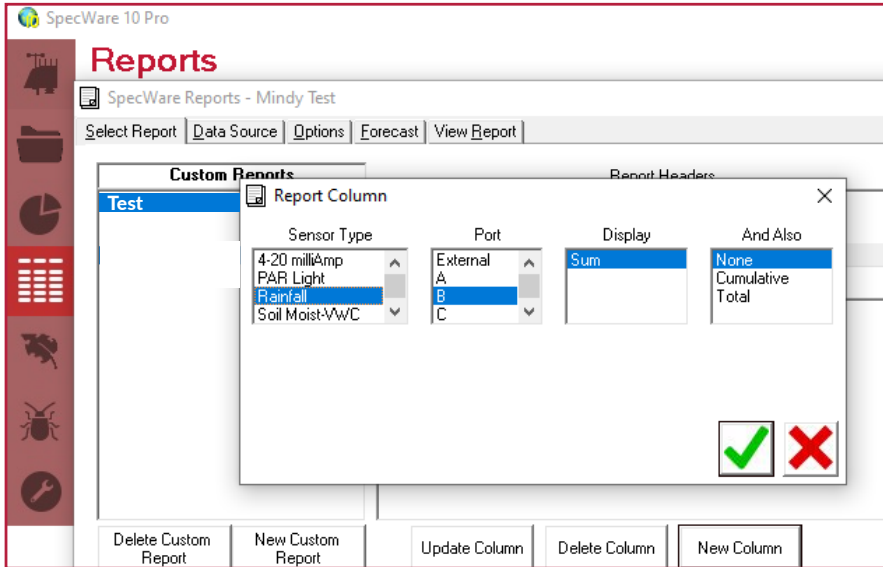

All standard reports, plus **CUSTOM** reports are available when using SpecWare PRO.

Select the sensor type to report on and choose how you want the data to display

Create additional custom reports as desired

Example of an Evapotranspiration (ET) report available using SpecWare PRO

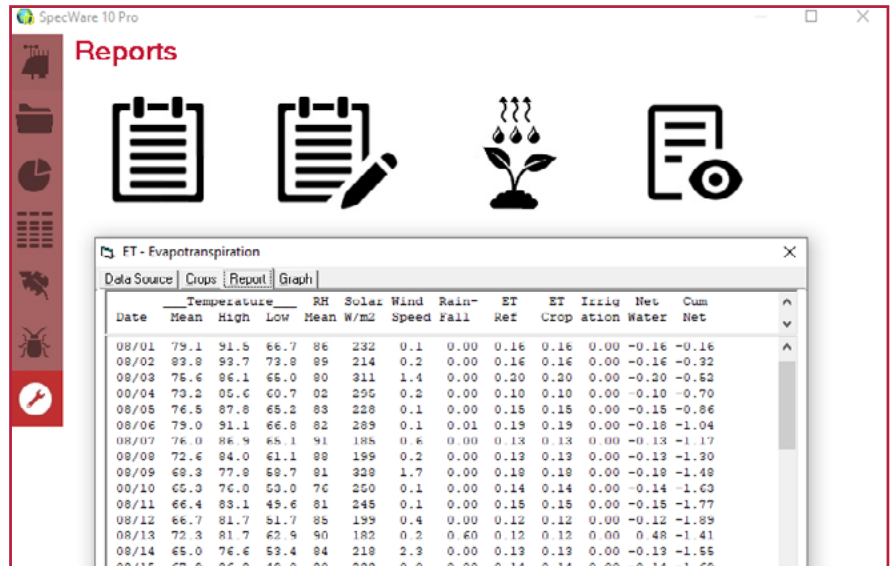

Example of Apple Scab report available with the purchase of Disease/Insect Models and using SpecWare PRO

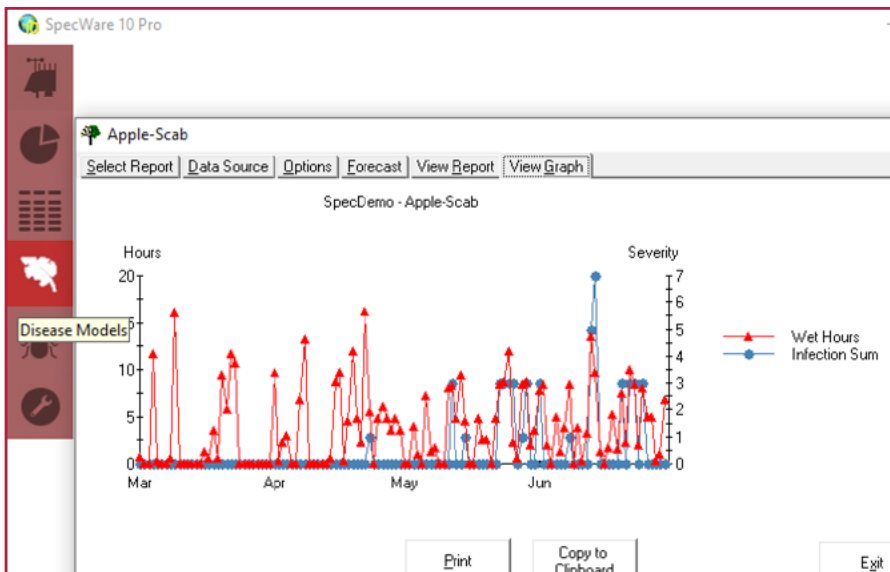

SpecWare Software

49

SpecWare
Software



DOWNLOAD NOW!

www.specmeters.com/specware10

Activation is Required

Item #	Item Description	Price
3654BX	SpecWare 10 Basic Software (USB cable included)	\$144.00
3654BXU	SpecWare 10 Basic Upgrade (USB cable not included)	\$ 68.00
3654BXX	SpecWare 10 Basic Extra User License (USB cable included)	\$ 84.00
3661U	USB to 3.5mm Stereo Plug Adapter	\$ 79.00
3654PX	SpecWare 10 Pro Software	\$254.00
3654PXU	SpecWare 10 Pro Upgrade	\$127.00
3654PXX	SpecWare 10 Pro Extra User License	\$148.00
3656TO	SpecWare Tomato Alert Package Required Sensors: Leaf Wetness and Temperature Models Included: Tom Cast, Insect Models	\$210.00
3656CH	SpecWare Cherry Alert Package Required Sensors: Leaf Wetness and Temperature Models Included: Leaf Spot, Insect Models	\$210.00
3656AP	SpecWare Apple/Pear Alert Package Required Sensors: Leaf Wetness and Temperature Models Included: Apple Scab (Modified Mills, Cornell, UC Davis California), Fire Blight (Maryblyt, CougarBlight), Sooty Blotch/Flyspeck, Insect Models	\$310.00
3656GA	SpecWare Grape Alert Package Required Sensors: Leaf Wetness, Temperature, Relative Humidity Models Included: Powdery Mildew (Thomas-Gubler), Black Rot Spots, Downey Mildew, Botrytis, Phomopsis Cane Leaf Spot, Insect Models	\$310.00
3656PO	SpecWare Potato Alert Package Required Sensors: Leaf Wetness and Temperature Models Included: Early Blight, Late Blight (BliteCast), Insect Models	\$310.00
3656TU	SpecWare Turf Alert Package Required Sensors: Air and Soil Temperature, Relative Humidity and Rain Models Included: Brown Patch (Schuman), Pythium (Nutter, Schein), Dollar Spot (Smith-Kerns, Hall, Mills/Rockwell), Insect Models	\$260.00

	BASIC	PRO
Viewing Data		
On Demand Graphing	✓	✓
Managing Data		
Calibration Adjustment	✓	✓
Automatic Data Append	✓	✓
Single File Per Logger	✓	✓
International Data Format	✓	✓
Reporting Data		
Standard Reports	✓	✓
Custom Reports		✓
Disease & Insect Models		Optional
Pest Alert Report Models		Optional
Communication		
USB	✓	✓
Direct Connect	✓	✓
Modem	✓	✓
Wireless Capability		✓
Cellular or WiFi Modem		✓
Auto Download		✓
Supported Products		
3000 Series Weather Stations		✓
Retriever & Pups Radio system		✓
1000 Series Micro Stations	✓	✓
A & B Series Data Loggers	✓	✓



Access data from your compatible WatchDog and FieldScout products on demand from your phone, PC or tablet using SpecConnect, our cloud-based subscription.

Save time, improve yield and quality, conserve resources, increase profits and decrease risk. View current conditions and factors in the app and then view and create reports in SpecConnect to better understand what is needed to improve your fields or turf!

SpecConnect is *required* if you are using a WatchDog 3000 Series Weather Station that uses Cellular or WiFi communication (not compatible with Data Recorders). It can also be used with the WatchDog Pup/Retriever Radio System when a DataScout modem is added.

In addition to WatchDog, SpecConnect works with both our FieldScout TDR350 and TDR150 soil moisture meters as well as the FieldScout TruFirm Turf Firmness meter.

SpecConnect supports data file uploads for the SPAD Meter, the FieldScout CM1000 Chlorophyll Meter, the FieldScout TCM500 NDVI Turf Color meter and the FieldScout SC900 Soil Compaction meter.

While data cannot be sent directly to the cloud for these products, you can still make use of all the features SpecConnect offers when you upload the data.



WHAT DOES SPECCONNECT OFFER?

WatchDog

- View Station Locations
- View Current Conditions
- Optional Disease/Insect Models
- Optional Alerts Function

FieldScout

- Data Overlay on Satellite Map
- Map Location of Sprinkler Heads
- Pin Locations

**Multiple User Logins Customizable Dashboard Easy Navigation
Standard and Custom Reports Downloadable Data**

SPECCONNECT REPORTING



51

SpecConnect Cloud Solution

SpecConnect Alert Support Feedback API Tuesday, Decemb

New Tab Edit Tabs

Choose from a variety of STANDARD reports already available for your use

Reports

- Multi Station/Sensor Report
- Hourly Report
- Daily Report
- European Food Safety Administration Report
- Single Station Export
- Degree Days Report
- DLI Report
- Chill Report
- Rainfall Report
- ET Report
- Wind Report
- Soil Moisture Report

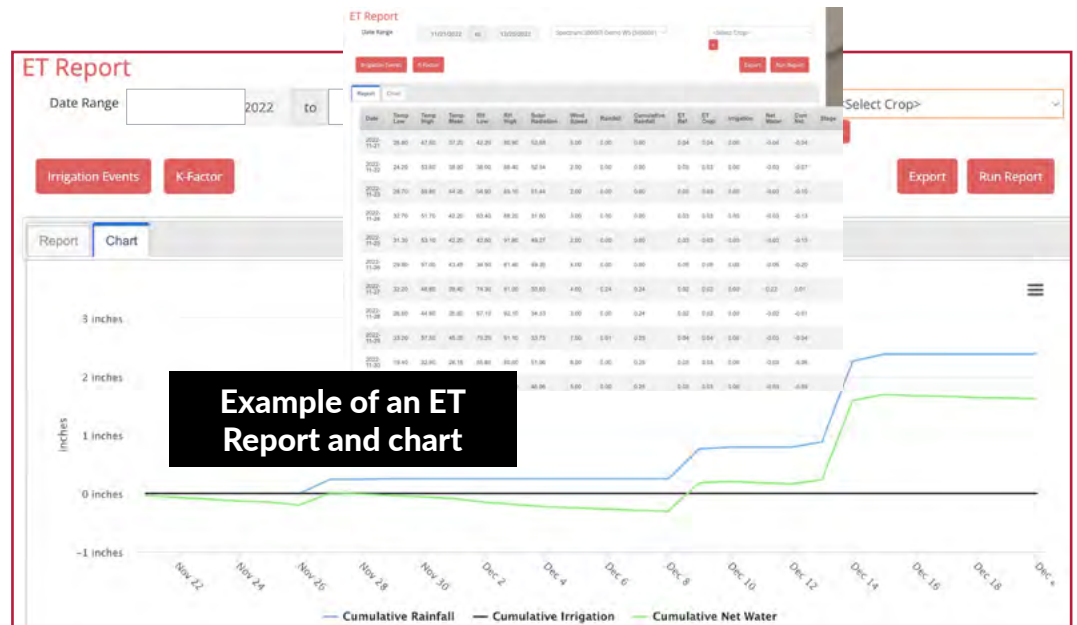

Custom Report Templates New Template

- Chill Hours Units and Portions* Edit
- Plant Growth (DIF/DLI) w/VPD* Edit
- Degree Days* Edit
- Irrigation - WaterScout WVC* Edit
- Irrigation - Watermark* Edit
- Leaf Wetness Hours* Edit
- NOAA report* Edit
- PAR Light* Edit
- Temperature / RH Hours* Edit
- Soil Temperature* Edit
- Summary (by Hour)* Edit
- Weather Summary* Edit

Create Custom Reports to collect and manipulate the data you need to show what's going on in your field or on your golf course



VWC in FREEFORM on a farm field



VWC in FREEFORM on a golf course



VWC in a GRID on a golf course

Your SpecConnect FieldScout PRO subscription allows collected data to be sent directly to the SpecConnect cloud for immediate viewing.

Through the SpecConnect portal, data can be overlaid on a satellite map, showing all data points within custom selected areas or groupings. Additionally sprinkler heads, and holes can also be visualized.

Choose the FieldScout product and data points you want to report on/display. Within the surface editor, you can create an outline of the surface area you are mapping. Once created, this area is saved so you do not have to recreate every time you take new measurements.

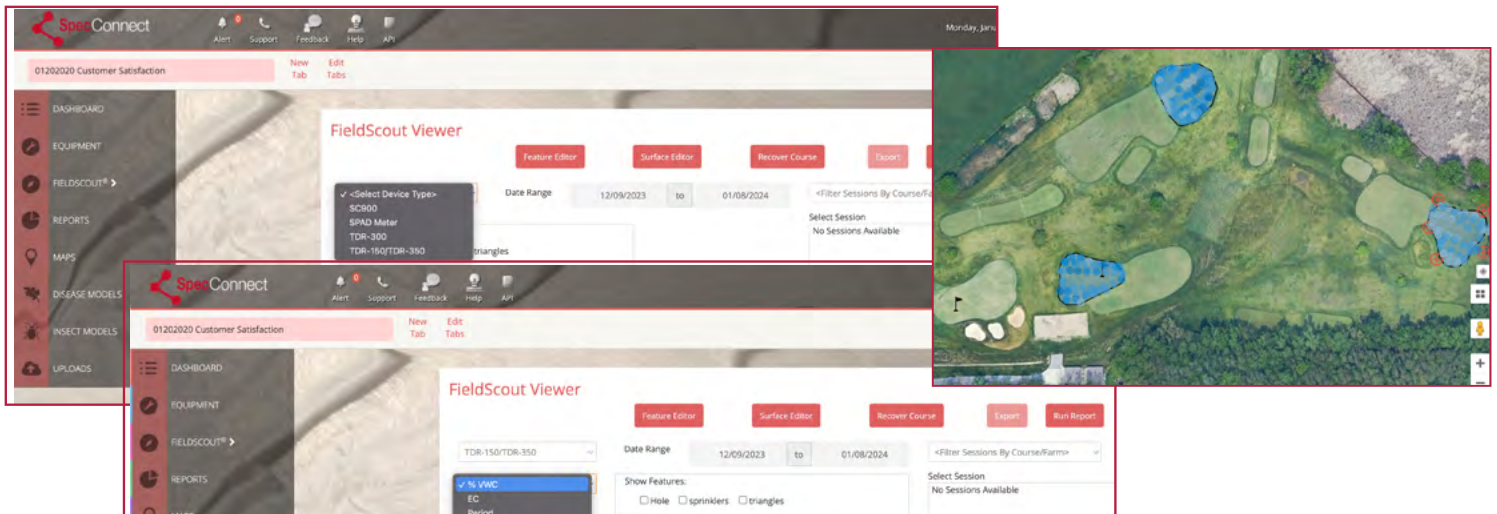

Once parameters are entered/collected, you can run the report. Select single or multiple sessions. This example shows the results from one session for EC, Surface Temperature and VWC%.

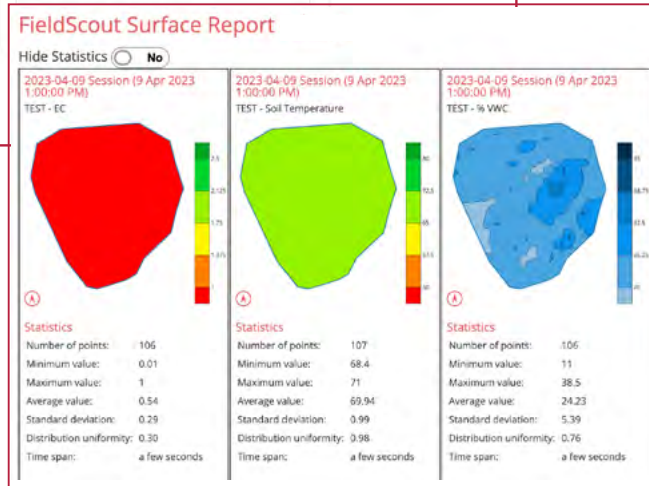

**DATA AT YOUR FINGERTIPS FOR
EDUCATED, QUICK DECISION MAKING!**



Item #	Item Description	Price
WatchDog Subscriptions		
3000	SpecConnect Initial Setup Fee	\$ 49.00
3010US	SpecConnect Pro 1-Year Cellular Subscription (US/Canada, per WatchDog Product)	\$295.00
3030	SpecConnect Pro 1-Year WiFi Subscription (US/Canada, per WatchDog Product)	\$195.00
Additional Devices/Services		
3065	API Service (One time charge)	\$ 49.00
3040	Additional Login (1-Year) (WatchDog or FieldScout Products)	\$ 24.00
3070	Alerts Function (1-Year) (WatchDog or FieldScout Products - Up to 4 phone numbers/emails)	\$ 99.00
3045US	Additional WatchDog Product - 1-Year Cellular (US/Canada) FOR NETWORKS ONLY	\$ 95.00
3046	Additional WatchDog Product - 1-Year Low Cellular FOR NETWORKS ONLY (US/Canada - 15-60 minute intervals for mean sensor values only)	\$ 99.00
3055	Additional WatchDog Product - 1-Year WiFi (US/Canada) FOR NETWORKS ONLY	\$ 24.00
FieldScout Subscriptions		
3035A	SpecConnect FieldScout Pro 1-Year Subscription (1-3 FieldScout Products)	\$224.00
3035B	SpecConnect FieldScout Pro 1-Year Subscription (4-7 FieldScout Products)	\$434.00
3035C	SpecConnect FieldScout Pro 1-Year Subscription (8+ FieldScout Products)	\$644.00
Disease & Insect Forecast Model Packages		
3095TOP	SpecConnect Tomato Alert Package <i>Required Sensors: Leaf Wetness and Temperature</i> <i>Models Included: Tom Cast, Insect Models</i>	\$ 149.00
3095CHP	SpecConnect Cherry Alert Package <i>Required Sensors: Leaf Wetness and Temperature</i> <i>Models Included: Leaf Spot, Insect Models</i>	\$ 149.00
3095APP	SpecConnect Apple/Pear Alert Package <i>Required Sensors: Leaf Wetness and Temperature</i> <i>Models Included: Apple Scab (Modified Mills, Cornell, UC Davis California), Fire Blight (Maryblyt, CougarBlight), Sooty Blotch/Flyspeck, Insect Models</i>	\$199.00
3095GAP	SpecConnect Grape Alert Package <i>Required Sensors: Leaf Wetness, Temperature, Relative Humidity</i> <i>Models Included: Powdery Mildew (Thomas-Gubler), Black Rot Spots, Downey Mildew, Botrytis, Phomopsis Cane Leaf Spot, Insect Models</i>	\$199.00
3095POP	SpecConnect Potato Alert Package <i>Required Sensors: Leaf Wetness and Temperature</i> <i>Models Included: Early Blight, Late Blight (BliteCast), Insect Models</i>	\$199.00
3095NUP	SpecConnect Nut Alert Package <i>Required Sensors: Leaf Wetness and Temperature</i> <i>Models Included: Almond Alternaria Leaf Spot, Almond Anthracnose, Pecan Scab, Pistachio Panicle and Shoot Blight, Walnut Blight, Insect Models</i>	\$199.00
3095TUP	SpecConnect Turf Alert Package <i>Required Sensors: Air and Soil Temperature, Relative Humidity and Rain</i> <i>Models Included: Brown Patch (Schumann), Pythium (Nutter, Schein), Dollar Spot (Hall, Mills/Rockwell), Insect Models</i>	\$199.00

**All
Packages Now
Include 7 Day
Forecast!**



See the latest and greatest in technology!

Learn what trade shows we will be attending!

Search our video library to gain more product knowledge!

Find out more about our office staff!

Be the first to know about upcoming promotions!

Share your success stories with us!

**Order Total****Shipping/Handling (USA Only)**

Charges Based
on Standard
Ground Shipments

For Express or
Delivery to Canada,
Contact Spectrum

\$25.01 to \$99.99	\$ 18.00
\$100.00 to \$499.99	\$ 24.00
\$500.00 to \$999.99	\$ 30.00
\$1,000.00 to \$1,999.99	\$ 35.00
\$2,000.00 to \$2,999.99	\$ 44.00
\$3,000.00 to \$4,999.99	\$ 56.00
\$5,000.00 to \$9,999.99	\$ 78.00
\$10,000 to \$20,000	\$ 136.00
\$20,000 and up	Contact for Pricing

ORDERING INFORMATION

Purchase Orders: We accept purchase orders from accredited universities, governments, businesses, and nonprofit organizations. Completed credit application may be required.

Terms: Net 30 days on approved Open Account purchases. A late payment charge of 1.5% per month or the maximum rate permitted by law, whichever is less, will be imposed on amounts unpaid after due date.

International Orders: Call, fax, or e-mail request for quote and terms

Dealers/Distributors: Call for quantity discounts

Prices: The pricing in this catalog is for calendar year 2025

Minimum Order: US: \$25.00 excluding S&H; Canada: \$75.00 excluding S&H

Spectrum Technologies, Inc. reserves the right to change the specifications, features, or prices of its products without prior notice or obligation.

**100% MONEY-BACK GUARANTEE**

YOUR SATISFACTION IS OUR BUSINESS

Order from Spectrum Technologies with total confidence. If you are not satisfied—for any reason—call our toll-free number for a Return Materials Authorization (RMA). Simply return the item you ordered within 30 days for a prompt refund, excluding shipping & handling fees. We ask that you return the item in restockable condition with all original packaging, parts, and instruction manuals included. Failure to meet these conditions may result in a restocking fee.

Spectrum[®] Technologies, Inc.

"To Measure Is To Know"

3600 Thayer Court
Aurora, Illinois 60504



Toll Free: 800.248.8873
Phone: 815.436.4440
Fax: 815.436.4460

info@specmeters.com
www.specmeters.com

Form 182
Jan 2026



NEW!!

WATERSCOUT[®]

WIRELESS SOIL MOISTURE PROFILER

MULTI-SENSOR PROBE

Each probe measures temperature and soil moisture (VWC) at multiple depths.

Choose your probe length based on your crop's root zone. (see pg. 31)

Soil Moisture Report

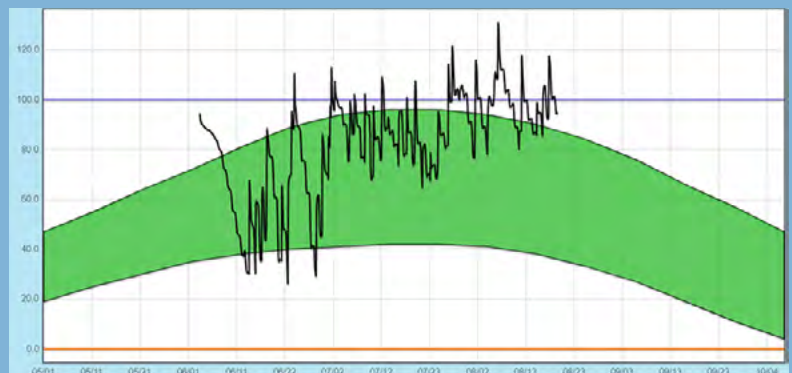

4"
8"
12"
16"
20"